

seed studio



NVIDIA® Jetson™-Powered Edge Devices

Your trusted hardware partner for advanced embedded AI systems.

seedstudio.com/nvidia-jetson.html

Manufacture in Shenzhen & Vietnam

Pioneering Embedded AI Partner

Support every stage of edge AI application



Sensor



Full product line from PoC to production

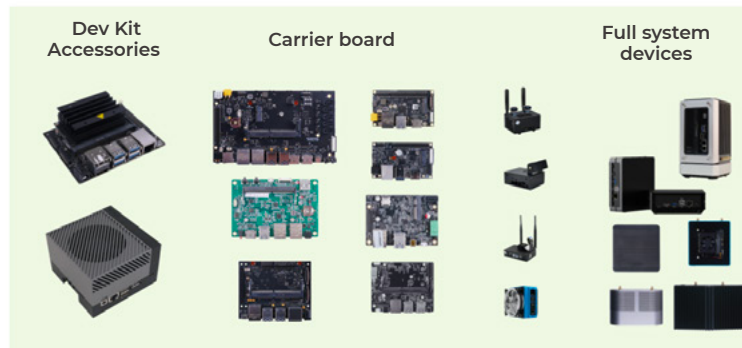

Design Tools, Tutorials, Software defined application

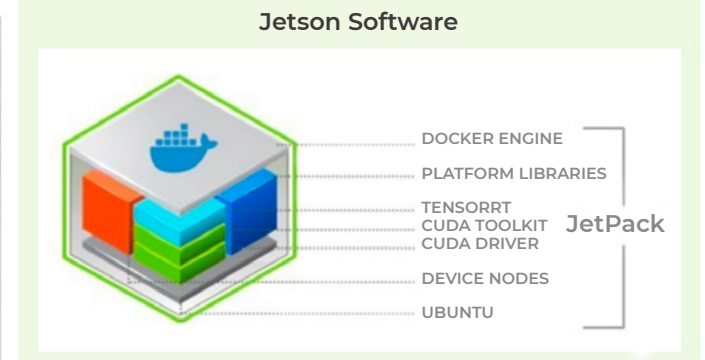

Agile Manufacturing
0.1-∞

- Decades hardware expertise
- Full stack of integration capability
- Industry trust worthy manufacturing partner
- One-stop go to market: fulfillment and global distribution.

The NVIDIA Jetson Family

For AI at the Edge and Autonomous Machines

Next-Gen: Jetson Orin

JETSON Orin Nano 4GB
20 TOPS (INT8)

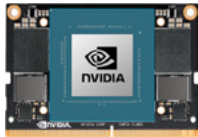

7 - 10W
45mm x 69.6mm

JETSON Orin Nano 8GB
40 TOPS (INT8)

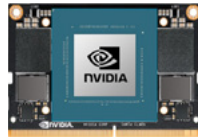

7 - 15W
45mm x 69.6mm

JETSON Orin NX 8GB
70 TOPS (INT8)

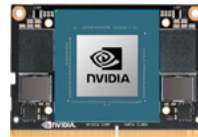

10 - 20W
45mm x 69.6mm

JETSON Orin NX 16GB
100 TOPS (INT8)

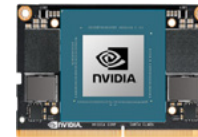

10 - 25W
45mm x 69.6mm

JETSON AGX Orin Series
275 TOPS (INT8)

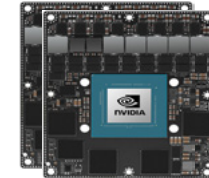

15- 60W
32GB/64GB
100mm x 87mm

Jetson Nano
0.5 TFLOPS (FP16)



5 - 10W
45mm x 69.6mm

JETSON TX2 NX
1.33 TFLOPS (FP16)



7.5 - 15W
45mm x 69.6mm

JETSON TX2 series
1.33 TFLOPS (FP16)



7.5 - 15W
50mm x 87mm

JETSON Xavier NX series
21 TOPS (INT8)



10 - 20W
8GB/16GB
45mm x 69.6mm

JETSON AGX Xavier Series
32 TOPS (INT8)

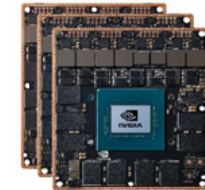

10-30w
32GB/64GB
100mm x 87mm

source: NVIDIA

Module Specifications

	Jetson AGX Xavier 32G	Jetson AGX Xavier 64GB	Jetson AGX Orin 32GB	Jetson AGX Orin 64GB
AI Performance	32 TOPS (Dense)		200 TOPS (Sparse) 100 TOPS (Dense)	275 TOPS (Sparse) 138 TOPS (Dense)
GPU	512-core NVIDIA Volta GPU with 64 Tensor Cores		1792-core NVIDIA Ampere GPU with 56 Tensor Cores	2048-core NVIDIA Ampere GPU with 64 Tensor Cores
DL Accelerator	2x NVDLA		2x NVDLA v2	
Vision Accelerator	2x PVA v1		PVA v2	
CPU	8-core NVIDIA Carmel Arm® v8.2 64-bit CPU 8MB L2 + 4MB L3		8-core NVIDIA Arm® Cortex A78AE v8.2 64-bit CPU 2MB L2 + 4MB L3	12-core NVIDIA Arm® Cortex A78AE v8.2 64-bit CPU 3MB L2+ 6MB L3
Memory	32GB 256-bit LPDDR4x @ 2133MHz 137 GB/s	64GB 256-bit LPDDR4x @ 2133MHz 137 GB/s	32 GB 256-bit LPDDR5 @ 3200MHz 204.8 GB/s	64 GB 256-bit LPDDR5@ 3200MHz 204.8 GB/s
Storage	32GB eMMC 5.1		64GB eMMC 5.1	
Video Encode	4x 4K60 8x 4K30 16x 1080p60 32x 1080p30 (H.265) H.264, VP9		1x 4K60 3x 4K30 6x 1080p60 12x 1080p30 (H.265) H.264, AV1	2x 4K60 4x 4K30 8x 1080p60 16x 1080p30 (H.265) H.264, AV1
Video Decode	2x8K30 6x4K60 12x4K30 26x 1080p60 52x 1080p30 (H.265) H.264, VP9		1x 8K30 2x 4k60 4x 4K30 9x 1080p60 18x 1080p30 (H.265) H.264, VP9, AV1	1x 8K30 3x 4k60 7x 4K30 11x 1080p60 22x 1080p30 (H.265) H.264, VP9, AV1
Camera	16 lanes MIPI CSI-2 (36 Virtual Channels) 8 lanes SLVS-ECI D-PHY 40Gbps / C-PHY 62 Gbps		16 lanes MIPI CSI-2 (16 Virtual Channels*) D-PHY 2.1 40Gbps / C-PHY 2.0 164Gbps	
PCI Express	16 lanes PCIe Gen 4 1 x8, 1 x4, 1x2, 2x1		22 lanes PCIe Gen 4 Up to 2 x8, 1 x4, 2 x1	
Ethernet	1 GbE RGMII		1 GbE RGMII 1x 10Gbe XFI	
Mechanical	100mm X 87mm 699 pin connector		100mm X 87mm 699 pin connector	
Power	10W to 30W		15W to 40W	15W to 60W

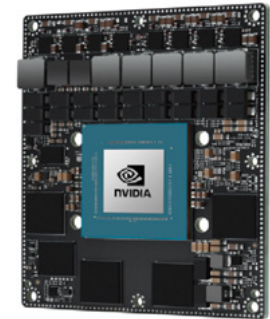

source: NVIDIA

Module Specifications

	Jetson Xavier NX 8GB	Jetson Xavier NX 16GB	Jetson Orin NX 8GB	Jetson Orin NX 16GB
AI Performance	21 TOPS (Dense)		70 TOPS (Sparse) 35 TOPS (Dense)	100 TOPS (Sparse) 50 TOPS (Dense)
GPU	384-core NVIDIA Volta™ GPU with 48 Tensor Cores		1024-core NVIDIA Ampere GPU with 32 Tensor Cores	
DL Accelerator	2x NVDLA		NVDLA v2	2x NVDLA v2
Vision Accelerator	2x PVA v1		PVA v2	
CPU	6-core NVIDIA Carmel ARM® v8.2 64-bit CPU 6MB L2 + 4MB L3		6-core NVIDIA Arm® Cortex A78AE v8.2 64-bit CPU 1.5MB L2 + 4MB L3	8-core NVIDIA Arm® Cortex A78AE v8.2 64-bit CPU 2MB L2 + 4MB L3
Memory	8 GB 128-bit LPDDR4x @1600 MHz, 51.2GB/s	16 GB 128-bit LPDDR4x @1600 MHz, 51.2GB/s	8GB 128-bit LPDDR5 @3200 MHZ 102.4 GB/s	16GB 128-bit LPDDR5 @3200MHZ 102.4 GB/s
Storage	16GB eMMC 5.1		-(Supports external NVMe)	
Video Encode	2x 4K60 4x 4K30 10x 1080p60 22x 1080p30 (H.265) H.264, H.265, VP9		1x 4K60 2x 4K30 5x 1080p60 11x 1080p30 (H.265) H.264, H.265, AV1	
Video Decode	2x 8K30 6x 4K60 12x 4K30 22x 1080p60 44x 1080p30 (H.265) H.264, H.265, VP9		1x8K30 2x4K60 4x4K30 9x1080p60 18x 1080p30 (H.265) H.264, H.265, VP9, AV1	
Camera	Up to 6 cameras (36 via virtual channels) 12 lanes MIPI CSI-2 D-PHY 1.2(up to 30 Gbps)		Up to 4 cameras (8 via virtual channels*) 8 lanes MIPI CSI-2 D-PHY 1.2(up to 20 Gbps)	
PCI Express	5 lanes PCIe Gen 3 1x4, 1x1		7 lanes PCIe Gen 4 1x4, 3x1	
Ethernet	1 GbE via MDI		1 GbE via MDI	
Mechanical	69.6mmx45mm 260-pin SO-DIMM connector		69.6mmx45mm 260-pin SO-DIMM connector	
Power	10W to 20W		10W to 20W	10W to 25W

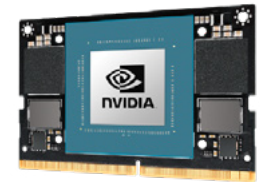

source: NVIDIA

Module Specifications

	Jetson Nano	Jetson TX2 NX	Jetson Orin Nano 4GB	Jetson Orin Nano 8GB
AI Performance	0.5 TFLOPS (Dense)	1.33 TFLOPS (Dense)	20 TOPS (Sparse) 10 TOPS (Sparse)	40 TOPS (Sparse) 20 TOPS (Sparse)
GPU	128-core NVIDIA Maxwell™ GPU	256-core NVIDIA Pascal™ GPU	512-core NVIDIA Ampere GPU with 16 Tensor Cores	1024-core NVIDIA Ampere GPU with 32 Tensor Cores
CPU	4-core Arm® Cortex®-A57 MPCore Processor, 1.5 GHz	2-core Denver 64-core CPU and 4-core Arm® Cortex®-A57 MPCore Processor 2.0 GHz	6-core NVIDIA Arm® Cortex A78AE v8.2 64-bit CPU, 1.5 GHz 1.5MB L2+ 4MB L3	6-core NVIDIA Arm® Cortex A78AE v8.2 64-bit CPU, 1.5 GHz 1.5MB L2+ 4MB L3
Memory	4 GB 64-bit LPDDR4x @1600 MHz, 25.6 GB/s	4 GB 128-bit LPDDR4x @1600 MHz, 51.2GB/s	4GB 64-bit LPDDR5 @2133 MHz, 34 GB/s	8GB 128-bit LPDDR5 @2133 MHz, 68 GB/s
Storage	16GB eMMC 5.1	16GB eMMC 5.1	-(Supports external NVMe)	-(Supports external NVMe)
Video Encode	1x 4K30 2x 1080p60 4x 1080p30 (H.265) H.264, H.265, VP9	1x 4K60 3x 4K30 4x 1080p60 8x 1080p30 (H.265) H.264, H.265, VP9	1080p30 supported by 1-2 CPU cores	1080p30 supported by 1-2 CPU cores
Video Decode	1x 4K60 2x 4K30 4x 1080p60 4x 1080p30 (H.265) H.264, H.265, VP9	2x 4K60 4x 4K30 7x 1080p60 14x 1080p30 (H.265) H.264, H.265, VP9	1x 4K60 3x 4K30 6x 1080p60 12x 1080p30 (H.265) H.264, H.265, VP9, AV1	1x 4K60 3x 4K30 6x 1080p60 12x 1080p30 (H.265) H.264, H.265, VP9, AV1
Camera	12 lanes MIPI CSI-2 D-PHY 1.2(up to 18 Gbps)	Up to 5 cameras (12 via virtual channels*) 12 lanes MIPI CSI-2 D-PHY 1.2(up to 30 Gbps)	Up to 4 cameras (8 via virtual channels*) 8 lanes MIPI CSI-2 D-PHY 1.2(up to 20 Gbps)	Up to 4 cameras (8 via virtual channels*) 8 lanes MIPI CSI-2 D-PHY 1.2(up to 20 Gbps)
PCI Express	4 lanes PCIe Gen 2 1x4	3 lanes PCIe Gen 2 1x2, 1x1	7 lanes PCIe Gen 2 1x4, 3x1	7 lanes PCIe Gen 3 1x4, 3x1
USB	1x USB 3.1 (5 Gbps)	1x USB 3.1 (5 Gbps)	3x USB 3.2 gen2 (10 Gbps)	3x USB 3.2 gen2 (10 Gbps)
Ethernet	1 GbE via MDI	1 GbE via MDI	1 GbE via MDI	1 GbE via MDI
Mechanical	69.6mmx45mm 260-pin SO-DIMM connector	69.6mmx45mm 260-pin SO-DIMM connector	69.6mmx45mm 260-pin SO-DIMM connector **	69.6mmx45mm 260-pin SO-DIMM connector **
Power	5W to 10W	7W to 15W	5W to 10W	7W to 15W



source: NVIDIA

Application Scenarios



AI Camera for Retail & Factory



Autopilot Robots & Cars



Drones



Education & Training Tools



Medical & Biological Vision



AI for Smart Retail

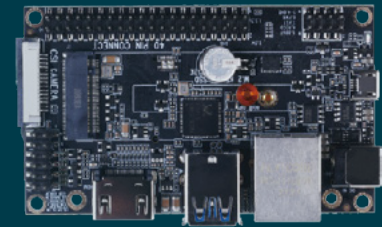
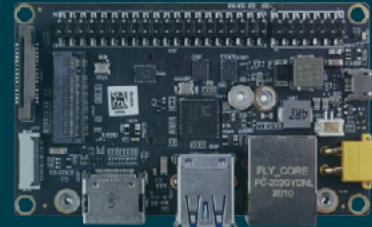
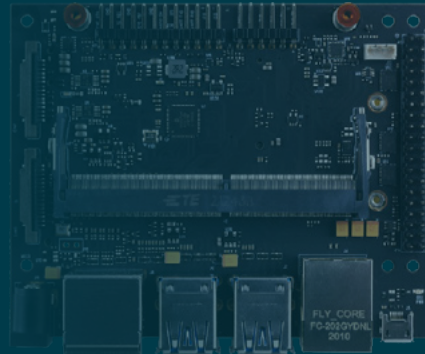

Carrier Boards for NVIDIA Jetson

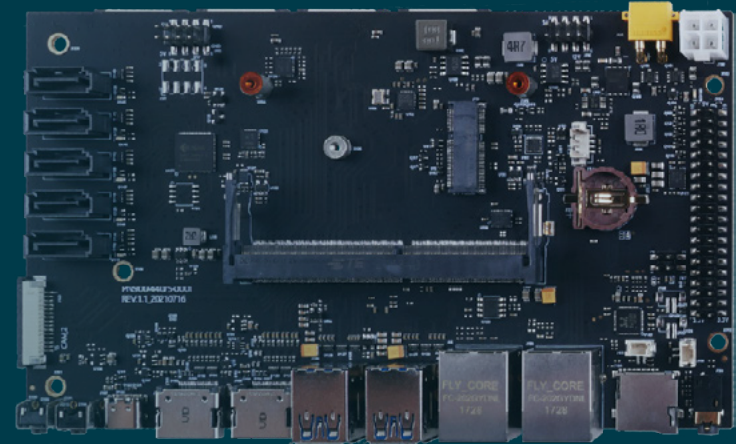
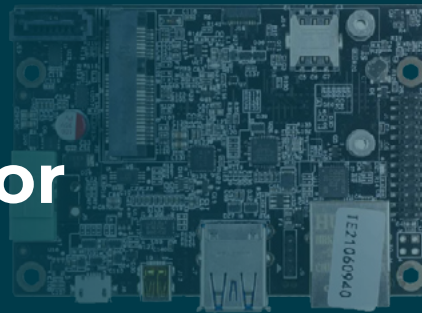

Designed For Different Edge AI Deployments

Various Form Factors Rich I/Os

Compatible with Jetson Orin Nano/ Orin NX

Compatible with Jetson Nano/ TX2 NX/ Xavier NX

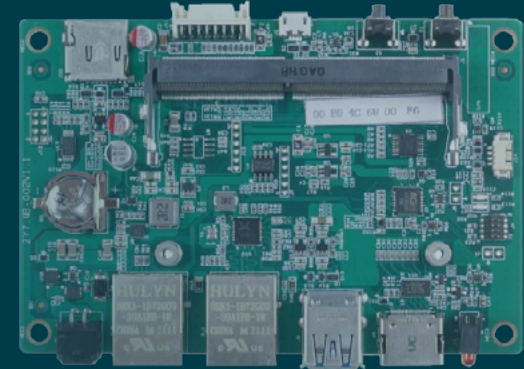
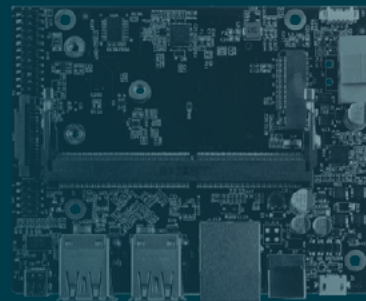

Carrier Board

Product Name	reComputer J101 carrier board
Dimensions	100mm x 80mm
Module Compatibility	Jetson Nano
SKU	102991694
Certification	

Introduction reComputer J101 is a cost-effective, high-performance, and interface-rich NVIDIA Jetson Nano compatible carrier board. It has nearly the same functional design and the same size as the carrier board of NVIDIA® Jetson Nano™ developer kit.

Features

- HDMI 2.0
- 3 USB Type A
- Micro SD Card Slot
- 2 CSI Camera Connectors
- M.2 Key E
- RTC

Applications

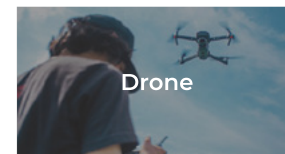
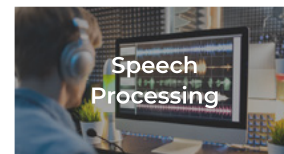
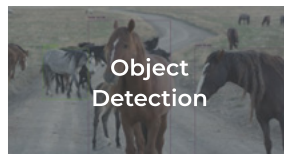
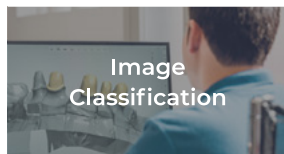
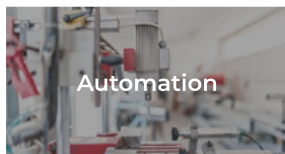

Same Dimensions As Jetson Nano Dev Kit Carrier Board

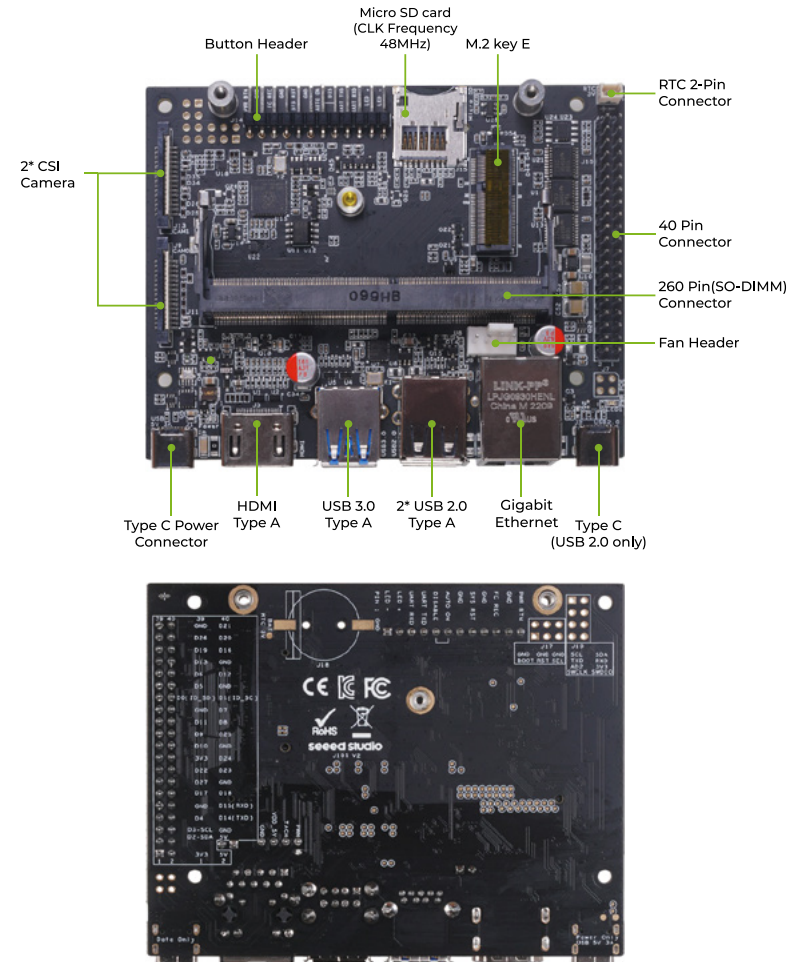

Carrier Board

Product Name	reComputer J202 carrier board
Dimensions	100mm x 80mm
Module Compatibility	- Jetson Nano - Jetson Xavier NX - Jetson TX2 NX
SKU	102991695
Japan Version	reComputer J202 (without power adapter) SKU 102991714
Certification	

Introduction reComputer J202 is a high-performance, interface rich NVIDIA Jetson Nano/Xavier NX/ TX2 NX compatible carrier board. It has the same functional design and size as the carrier board of NVIDIA® Jetson Xavier™ NX developer kit and NVIDIA® Jetson Nano Developer Kit-B01.

Features

- 4 USB 3.1 Type A ports
- 2 CSI Camera Connectors
- M.2 key E
- M.2 key M
- RTC
- HDMI + DP ports

Applications

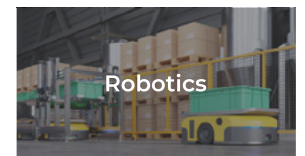
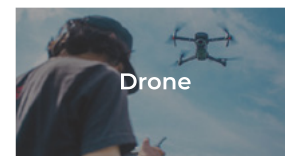
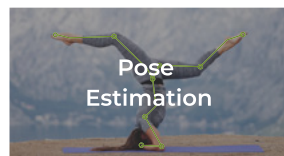

Same Dimensions As Jetson Nano Dev Kit Carrier Board

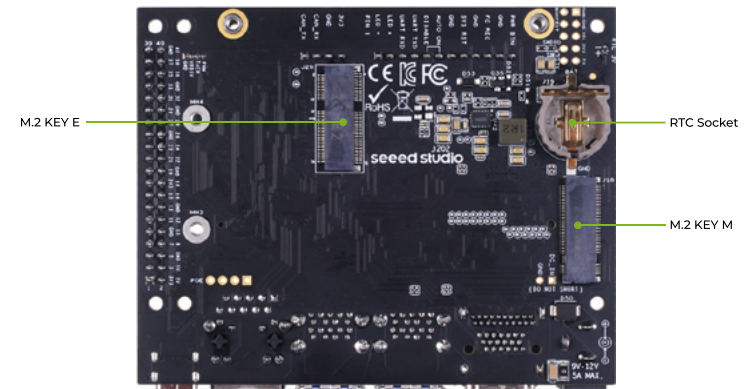
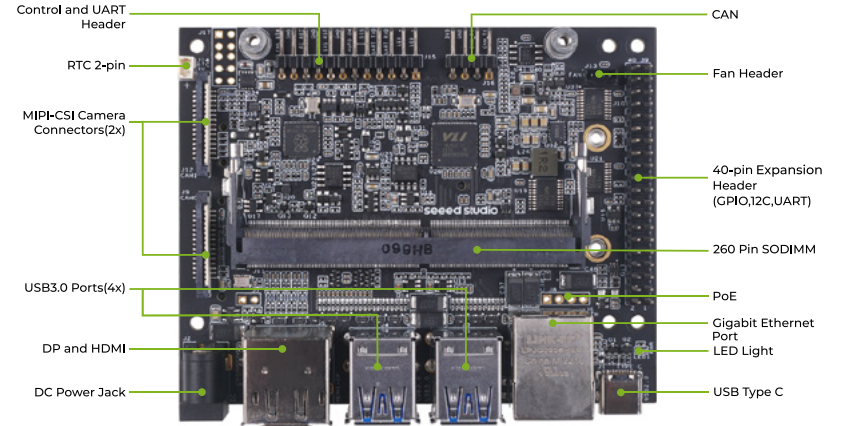

Carrier Board

Orin NX/ Orin Nano

Product Name	reComputer J401 carrier board
Dimensions	100mm x 80mm
Module Compatibility	- Jetson Orin Nano - Jetson Orin NX
SKU	102110769
Japan Version	reComputer J401 (without power adapter) SKU 102110770
Certification	

Introduction reComputer J401 is a high-performance, interface rich NVIDIA Jetson Orin Nano/ Orin NX compatible carrier board. It has the same functional design and size as the carrier board of NVIDIA® Jetson Orin™ Nano Developer Kit

Features

- 4 USB 3.2 Type A ports
- 2 CSI Camera Connectors
- 9V-19V
- M.2 key E
- M.2 key M
- RTC
- HDMI

Applications

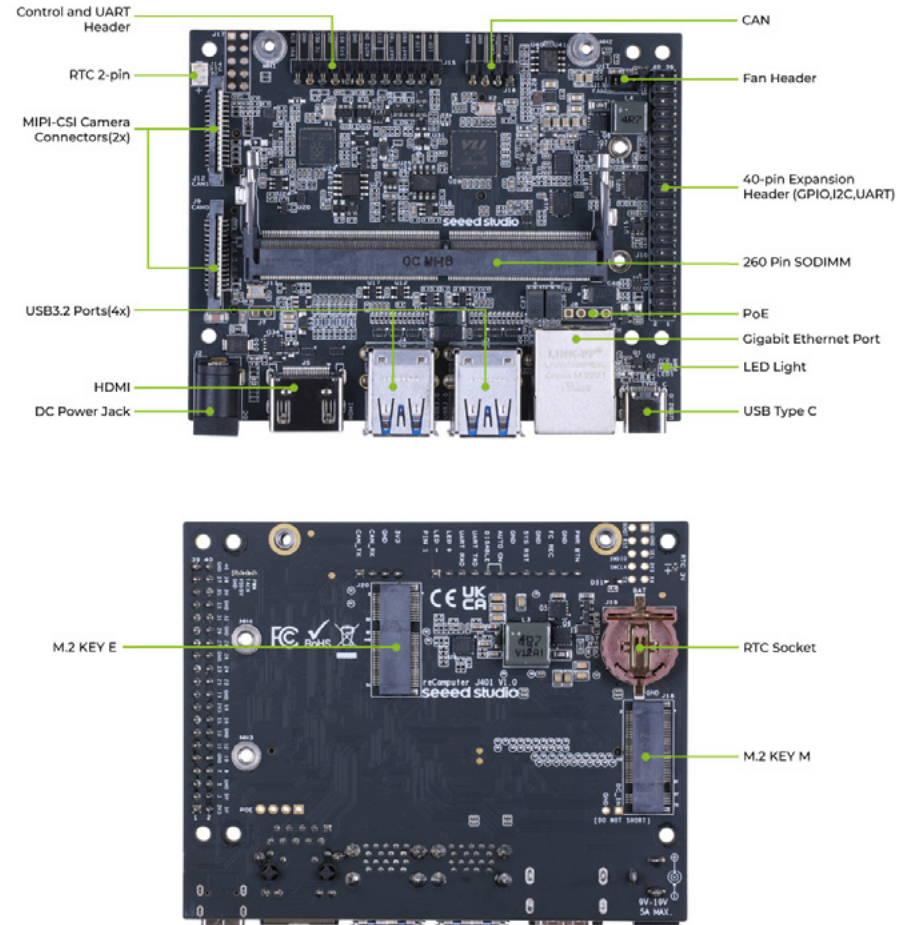
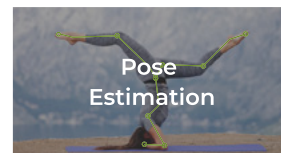
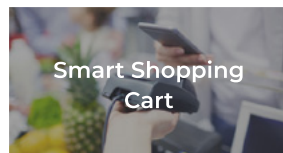

Carrier Board

Product Name	A205E carrier board
Dimensions	115mm x 105mm
Module Compatibility	- Jetson Nano - Jetson Xavier NX - Jetson TX2 NX
SKU	<u>102110774</u>
Certification*	

Introduction Designing for industrial communication use, A205E provides RS232, RS485, and CAN interfaces, high-speed PCIe M.2 Key M(SSD), and M.2 Key E(Wi-Fi). It also provides a rich set of I/Os including a microSD card slot, HDMI, dual Gigabit Ethernet, 4x USB 3, USB2.0 Type C, SPI, I2C, GPIO, and a fan for different application needs. The board supports operate in the temperature range from -25°C to 80°C.

Features

- 4 USB 3.0 Type A
- USB2.0 Type C
- CAN
- Dual Gigabit Ethernet
- M.2 key E
- M.2 key M
- RS485
- RS232

Applications



*Some of certification is on going

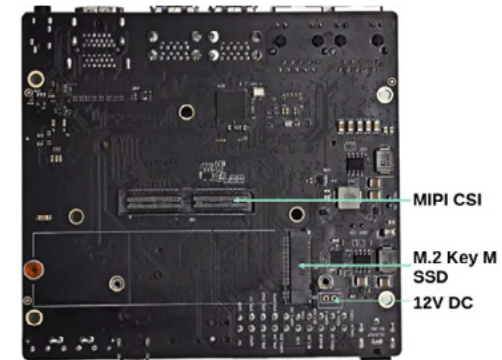
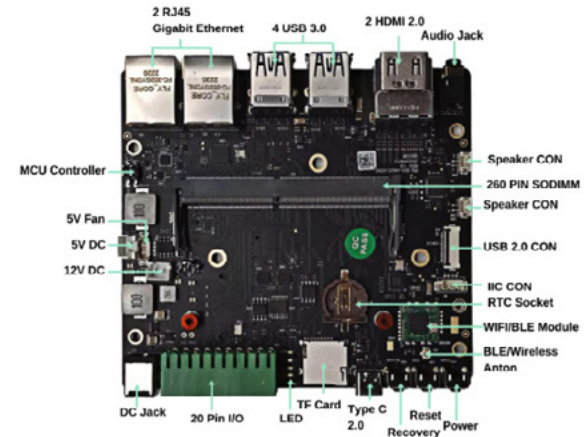

Carrier Board

Product Name **A203 V2 carrier board**

Dimensions 87mm x 52mm

Module Compatibility
 - Jetson Nano
 - Jetson Xavier NX
 - Jetson TX2 NX

SKU [103110043](#)

Certification 

Introduction It is a high-performance, interface rich Jetson Nano/Xavier NX/TX2 NX compatible carrier board.
 Compared with Jetson Xavier NX carrier board, it is much smaller and thus is suitable for small size AI graphical applications, such as smart-city IoT edge devices, home robots, UAVs, unmanned boats and unmanned submarines.

Features

- Small and compact
- 9V-19V
- RTC
- M.2 E key
- SD card slot
- USB 3.0 ZIF connector

Applications

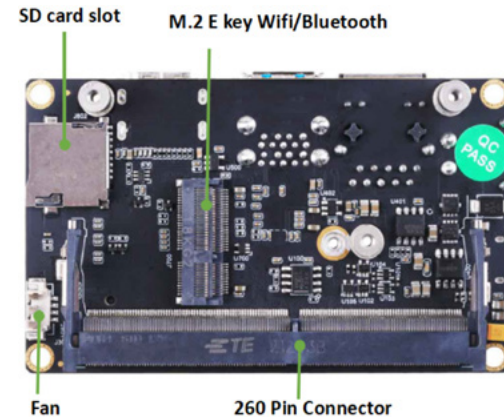
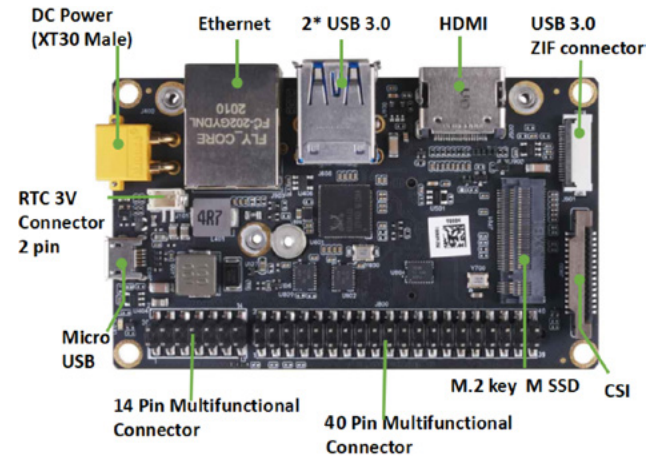
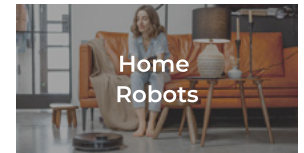
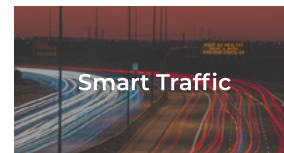
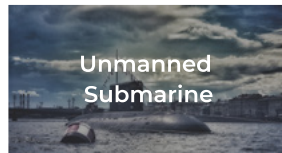
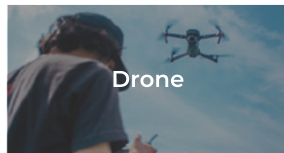

Carrier Board

Product Name **A205 carrier board**

Dimensions 170mm x 100mm

Module Compatibility
 - Jetson Nano
 - Jetson Xavier NX
 - Jetson TX2 NX

SKU [114110048](#)

Certification 

Introduction Bigger size compared with Jetson Xavier NX carrier board.
 Its rich SATA and multiple CSI Camera connectors make it suitable for complicated AI graphical applications, such as automated optical inspection, in video action, robot control, 3D modeling, drone, and parallel computing for computer vision.

Features

- Dual Gigabit Ethernet
- 6 CSI
- 5 SATA
- SD card slot
- 2 Ethernet Ports
- 4 USB 3.0 Type A

Applications

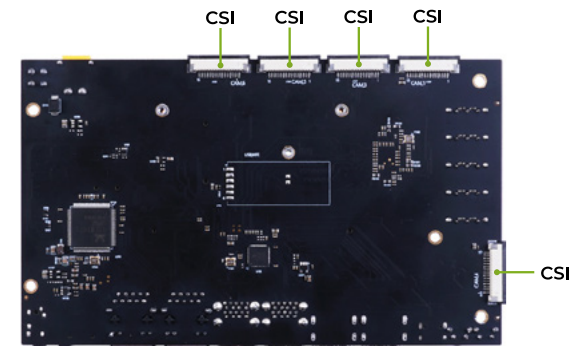
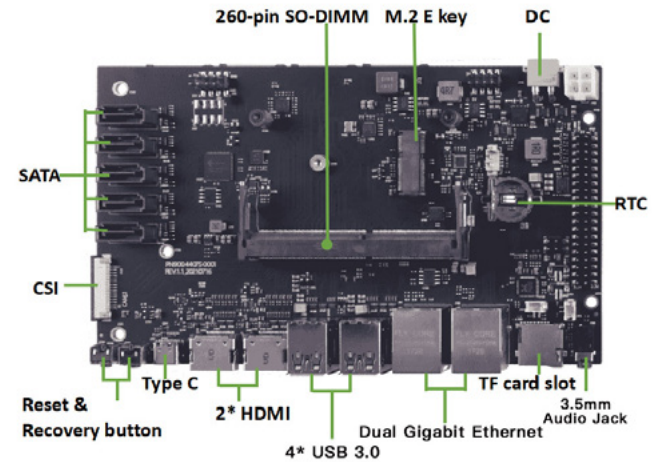
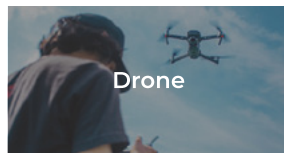

Carrier Board

Product Name **A603 carrier board**

Dimensions 87mm x 52mm

Module Compatibility
-Jetson Orin NX
-Jetson Orin Nano

SKU [102110840](#)

Certification 

Introduction A603 Jetson Carrier Board is a powerful extension board that supports Jetson Orin™ NX/ Orin™ Nano modules. It features 1 GbE port, M.2 Key M for SSD, M.2 Key E for Wi-Fi/Bluetooth, CSI, and HDMI for high-quality video capture and display, containing 2x USB 3.0 ports, fan, RTC, flexible 9-20V power supply. By the compact design, it can be flexible and easy to integrate into a variety of edge computing applications, saving space for UAVs, robots and drone development.

Features

- Compact design
- 9V - 20V
- M.2 Key E
- RTC
- 2 x USB 3.0
- 20-pin ZIF

Applications

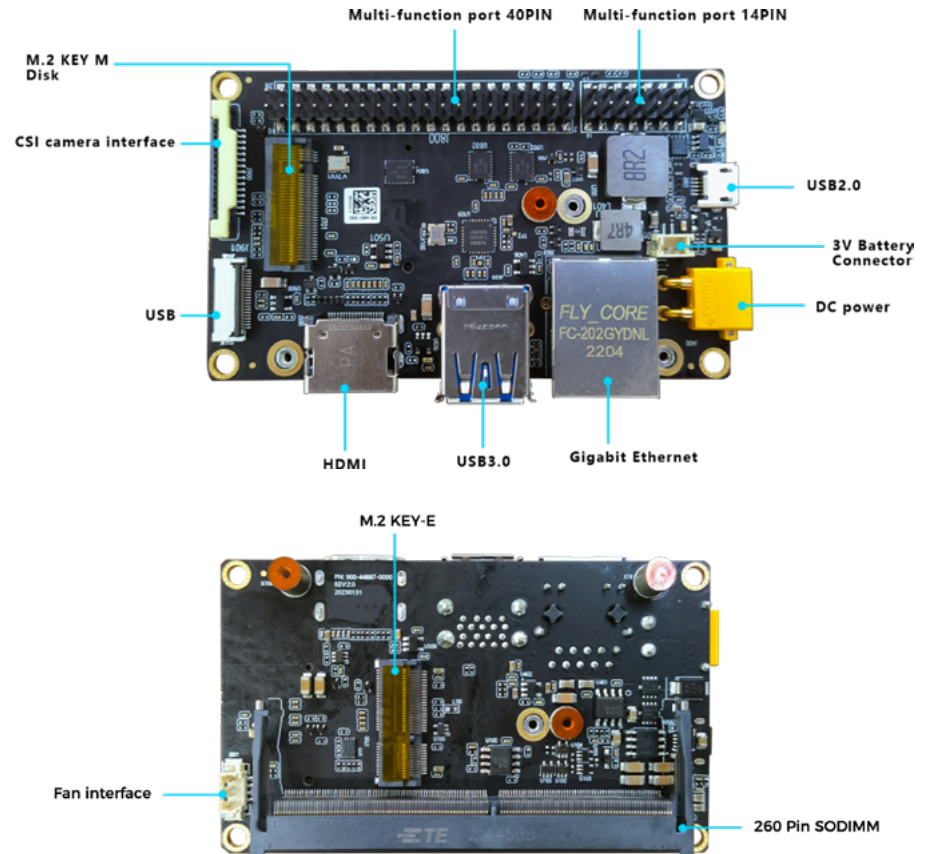
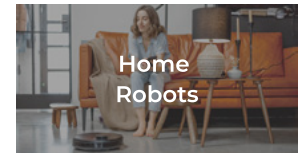
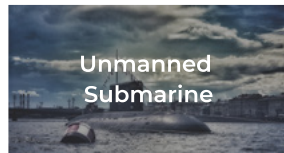
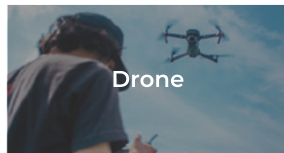

Carrier Board

Product Name **A607 carrier board**

Dimensions 115mm x 105mm

Module Compatibility
-Jetson Orin NX
-Jetson Orin Nano

SKU [102110841](#)

Certification 

Introduction

A607 Jetson Carrier Board is a powerful extension board that supports Jetson Orin™ NX/ Orin™Nano modules, featuring high-speed networking and wireless connection with two GbE network ports and a pre-installed SMD WiFi/Bluetooth module. It also comes with CAN, I2C Link, four USB 3.0 Type-A ports, one USB 2.0 / USB 3.0 Type-C, and one USB 3.0 0.5mm pitch 20-pin ZIF for versatile connectivity options. This extension board can enable users to capture and display video content with the 120-pin expansion camera connector and the HDMI port, supporting a wide input range of 12-36V DC, making it flexible to integrate into a variety of computing tasks. It maintains operation in the temperature range from -25°C to 75°C.

Features

2 GbE network ports

pre-installed SMD Wi-Fi/Bluetooth

M.2 Key M for SSD

CAN/RS232/RS485

Applications

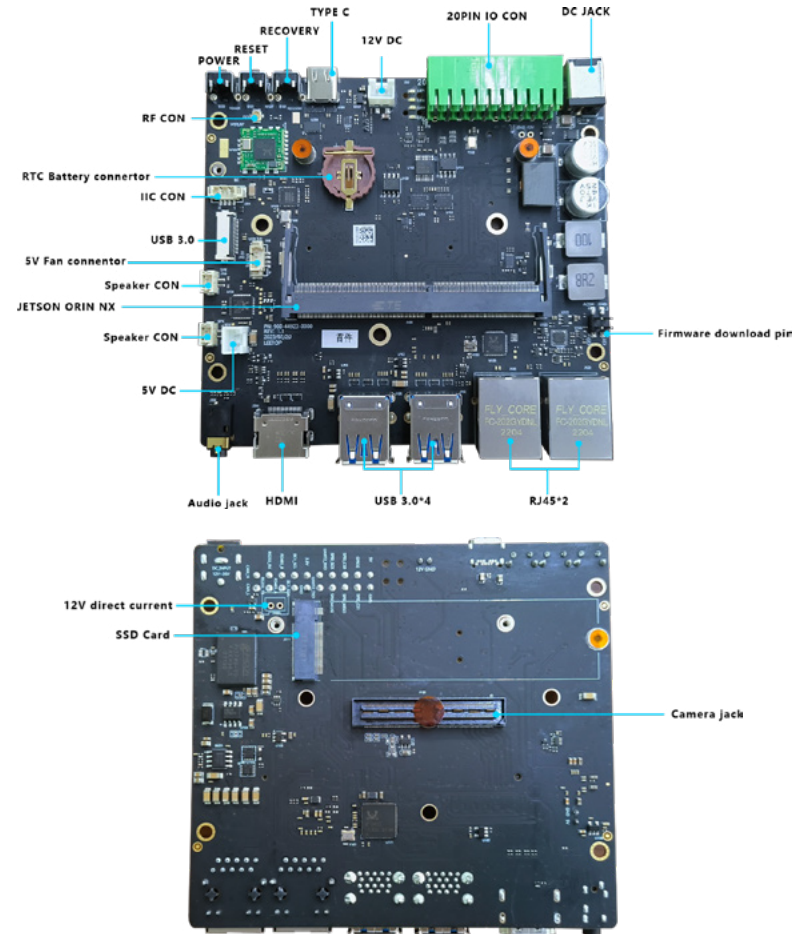
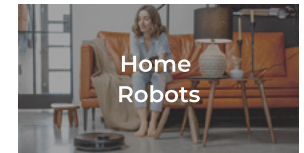
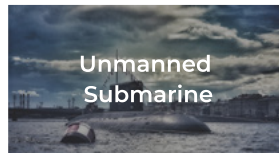
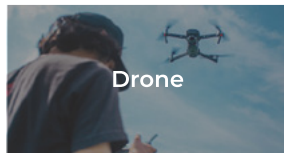

Carrier Board

Product Name **A608 Carrier Board** NEW

Dimensions 101.5mm x 95mm

Module Compatibility -Jetson Orin NX
-Jetson Orin Nano

SKU [105110001](#)

Certification 

Introduction

A608 Jetson Carrier Board is a powerful extension board that supports Jetson Orin™ NX/Orin™ Nano modules, featuring 2 Gigabit Ethernet ports for fast networking, also coming with 4 USB 3.2 Type-A (integrated USB 2.0) ports, 1 USB2.0+3.2 Type-C port and 1 CAN connector for versatile interface options. This carrier board has been mounted with 1 M.2 Key M, 1 M.2 KEY E and 1 M.2 Key B slots with ample space for flexible storage and wireless connectivity expansion. It's a good choice for handling computer vision tasks, robotics/drone development, and intelligent Generative AI applications in diverse industries. It's especially compatible with JST-GH ports to seamlessly integrate on drones/robots through rich Function CON interfaces, in order to get stable connection in dynamic and collision environments.







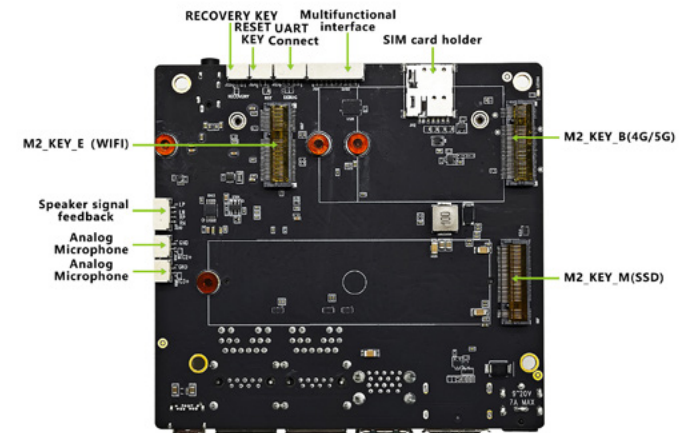
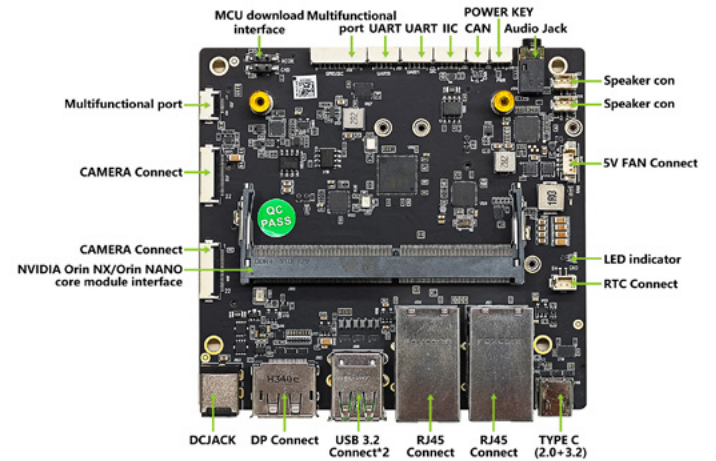
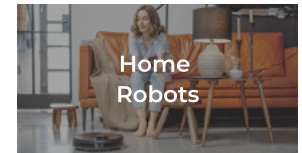
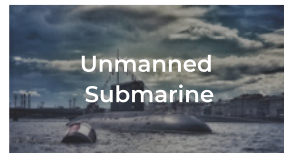
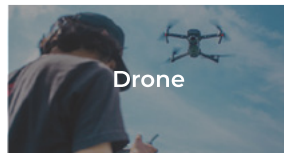

Features

- 2 GbE network ports
- 5 USB
- 2 4-lane CSI Camera ports
- M.2 Key M for SSD
- M.2 KEY B for 4G/5G
- M.2 KEY E for WiFi
- 9-20V DC(MAX 60W)

Applications



NVIDIA®Jetson Module Compatible Carrier Boards Comparison

									
Carrier board	reComputer J101 carrier board for Jetson™ Nano	reComputer J202 carrier board for Jetson™ Nano/NX/TX2 NX	reComputer J401 carrier board for Jetson™ Orin NX/Orin Nano	A203 V2 carrier board for Jetson™ Nano/NX/TX2 NX	A205 carrier board for Jetson™ Nano/NX/TX2 NX	A205E Carrier Board for Jetson™ Nano/Xavier NX TX2 NX	A603 carrier board for Jetson Orin™ NX/Nano	A607 carrier board for Jetson Orin™ NX/Nano	A608 carrier board for Jetson Orin™ NX/Nano
Module Compatibility	NVIDIA® Jetson™ Nano	NVIDIA® Jetson™ Nano/ Xavier NX/TX2 NX	NVIDIA® Jetson™ Orin NX/Orin Nano	NVIDIA® Jetson™ Nano/ Xavier NX/TX2 NX	NVIDIA® Jetson™ Nano/ Xavier NX/TX2 NX	NVIDIA® Jetson™ Nano/Xavier NX/TX2 NX	NVIDIA® Jetson Orin™ NX/Nano	NVIDIA® Jetson Orin™ NX/Nano	NVIDIA® Jetson Orin™ NX/Nano
PCB Size / Overall Size	100mm x 80mm	100mm x 80mm	100mm x 80mm	87mm x 52mm	170mm x 100mm	115mm x 105mm	87mm x 52mm	115mm x 105mm	101.5mm x 95mm
Display	1 x HDMI	1 x HDMI+1 x DP	1 x HDMI	1 x HDMI	2 x HDMI	2 x HDMI	1 x HDMI	1 x HDMI	1 x DP
CSI Camera	2 x CSI	2 x CSI	2 x CSI	1 x CSI	6 x CSI	1 x CSI	1x 15 pins CSI Camera connect	/	2x 4 CSI Camera
Networking	1 x Gigabit Ethernet (10/100/1000M) 1 x M.2 KEY E (WiFi) (module not included)	1 x Gigabit Ethernet (10/100/1000M) 1 x M.2 KEY E (WiFi) (module not included)	1 x Gigabit Ethernet (10/100/1000M) 1 x M.2 KEY E (WiFi) (module not included)	1 x Gigabit Ethernet (10/100/1000M) 1 x M.2 KEY E (WiFi) (module not included)	2 x Gigabit Ethernet (10/100/1000M) 1 x M.2 KEY E (WiFi) (module not included)	2 x Gigabit Ethernet Connector (10/100/1000) 1 x M.2 KEY E(WiFi) (module not included) 1 x WiFi/BLE module (4 pin interface)	1 x Gigabit Ethernet (10/100/1000)	2 x Gigabit Ethernet (10/100/1000)	2x Gigabit Ethernet (10/100/1000)
USB	1 x USB 3.0 Type-A 2 x USB 2.0 Type-A 1 x USB Type C(Not support power input)	4 x USB 3.1 Type-A (Integrated USB 2.0) 1 x USB Type C(Not support power input)	4 x USB 3.2 Type-A (Integrated USB 2.0) 1 x USB Type C(Not support power input)	1 x USB 3.0 0.5mm pitch 20Pin ZIF 2 x USB 3.0 Type-A (Integrated USB 2.0) 1 x USB Micro B(Not support power input)	4 x USB 3.0 Type-A (Integrated USB 2.0) 1 x USB 2.0 Type C (Support OTG)	1x USB 2.0 ZIF 20P 0.5mm pitch 4x USB 3.0 Type A 1x USB 2.0 Type C	2 x USB 3.0 Type A (Integrated USB 2.0) 1 x USB 3.0 0.5mm pitch 20P ZIF 1 x USB 2.0 Micro-AB	4 x USB 3.0 Type A (Integrated USB 2.0) 1 x USB 2.0 / 3.0 Type C 1 x USB 3.0 ZIF 20P 0.5mm pitch	4x USB 3.2 Type A (Integrated USB 2.0) 1x USB 2.0+3.2 Type C
Storage Expansion	1 x TF_Card (CLK Frequency 48Mhz)	1 x M.2 KEY M	1 x M.2 KEY M	1 x M.2 KEY M 1 x TF_Card	5 x SATA 1 x TF_Card	1 x M.2 KEY M (NVMe SSD) MicroSD card slot	1 x M.2 KEY M 2242 Interface	1 x M.2 KEY M	1x M.2 KEY M
Audio	/			1 x Audio Jack 2 x Microphone interface 2 x Speaker interface		1 x Audio Jack, 2 x Speaker	/	1 x speaker Connector 1 x audio Jack	1x 3.5 Audio Jack 2x MIC 2x SPEAKER 1x SPEAKER FEEDBACK
SPI Bus	2 x SPI Bus(+3.3V Level)	2 x SPI Bus(+3.3V Level)	2 x SPI Bus(+3.3V Level)	2 x SPI Bus(+3.3V Level)	2 x SPI Bus(+3.3V Level)	1 x SPI Bus(+3.3V Level)	2 x SPI Bus	2 x SPI Bus	1x SPI BUS
Fan Connector	1 x Fan(5V PWM)	1 x Fan(5V PWM)	1 x Fan(5V PWM)	1 x Fan(5V PWM)	2 x Fan(12V/5V) 1 x Fan(5V PWM)	1 x FAN(5V PWM)	1x FAN connector(5V PWM)	1x FAN connector(5V PWM)	1x FAN(5V PWM)
CAN	/	1 x CAN	1 x CAN	1 x CAN	1 x CAN	1 x CAN	1 x CAN	1 x CAN	1x CAN (FD)
Multifunctional port	1 x 40-Pin	1 x 40-Pin	1 x 40-Pin	1 x 40-Pin	1 x 40-Pin	1 x 40-Pin	1 x 40-Pin	1 x 40-Pin	2x IIC; 7x IO 3.3V; 2x UART; 1x DEBUG; 1x POWER; 1x RESET; 1x RECOVERY
RTC	Battery not included	Battery not included	Battery not included	Battery not included	Battery not included	Battery not included	1 x RTC socket(rechargeable 3V Lithium Battery Connector)	1 x RTC socket(support rechargeable battery)	1x 3.0V RTC
Power supply	USB Type C 5V/3A (not include a power cord)	12V/5A power cord only	12V/5A power cord only	19V/4.74A power cord only	19V/4.74A power cord only	9V-36V DC	9-20V DC, 7A	12(7A) - 36V(3A) DC	9-20V(MAX 60W) DC
Operating Temperature	0°C~60°C	0°C~60°C	-10°C~60°C	-25°C ~65°C	-25°C ~80°C	-25°C ~80°C	-25°C ~65°C	-25°C~75°C	-25°C to~65°C

seed studio



reComputer Series for NVIDIA Jetson

Hand-size Edge AI Device Built with NVIDIA
Advanced AI Embedded Systems

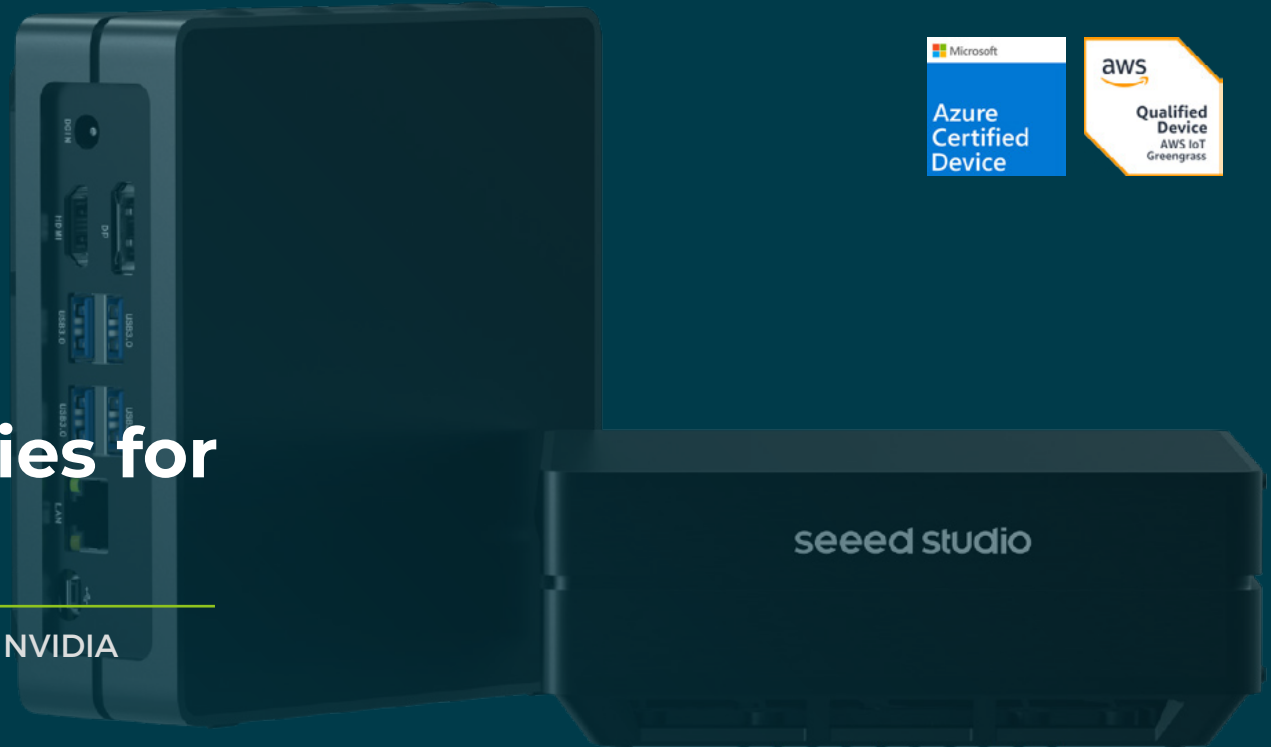

Same Dimension Carrier Board as Official Dev Kit

Jetson Nano/Xavier NX/Orin NX/Orin Nano

Pre-installed Jetpack

Production module

Module Embedded

- Jetson Nano
- Jetson Xavier NX 8GB/16GB
- Jetson Orin NX 8GB/16GB
- Jetson Orin Nano 4GB/8GB

Introduction

reComputer series for Jetson are compact edge computers built with NVIDIA advanced AI embedded systems. With rich extension modules, industrial peripherals, and thermal management, reComputer for Jetson is ready to help users accelerate and scale the next-gen AI product by deploying popular DNN models and ML frameworks to the edge and inferencing with high performance.

Dimensions

130mm*120mm*50mm

Features

- Edge AI box with production module
- Pre-installed Jetpack
- Rich set of I/Os
- Stackable and expandable



Products Overview

Available Version:

reComputer J10 Series

- Jetson Nano
- 4xUSB 3.0
- M.2 key M

SKU: [110061362](#) / [110061441](#)

Certification:

reComputer J20 Series

- Jetson Xavier NX 8GB / 16GB
- 4xUSB 3.1
- M.2 key M, M.2 key E

SKU: [110061381](#) / [110061402](#)

Certification:

reComputer J30 Series

- Jetson Orin Nano 4GB/ 8GB
- 4x USB 3.2 Type-A; 1x USB2.0 Type-C (Recovery)
- M.2 key M, M.2 key E
- 128GB SSD
- WiFi/Bluetooth

SKU: [110110146](#) / [110110147](#)

Certification:

reComputer J40 Series

- Jetson Orin NX 8GB/ 16GB
- 4x USB 3.2 Type-A; 1x USB2.0 Type-C(Recovery)
- M.2 key M, M.2 key E
- 128GB SSD

SKU: [110110144](#) / [110110145](#)

Certification:

reComputer Industrial J20 Series

- Jetson Xavier NX 8GB/ 16GB
- 3x USB3.2
- dual GbE
- PoE
- RS232/422/485
- fanless design

SKU: [110110188](#) / [110110189](#)

Certification:

reComputer Industrial J30 Series

- Jetson Orin Nano 4GB/ 8GB
- 3x USB3.2
- dual GbE
- PoE
- RS232/422/485
- fanless design

SKU: [110110192](#) / [110110193](#)

Certification:

reComputer Industrial J40 Series

- Jetson Orin NX 8GB/ 16GB
- 3x USB3.2
- dual GbE
- PoE
- RS232/422/485
- fanless design

SKU: [110110190](#) / [110110191](#)

Certification:

Discontinued

reComputer J1020

- Jetson Nano
- 4xUSB 3.0
- M.2 key M

SKU: [110061361](#)

Certification:

reComputer J2011

- Jetson Xavier NX
- 4xUSB 3.0
- M.2 key M, M.2 key E

SKU: [110061363](#)

Certification:

reComputer J2012

- Jetson Xavier NX 16GB
- 4xUSB 3.0
- M.2 key M, M.2 key E

SKU: [110061401](#)

Certification:

Optional accessories:

- 128GB NVMe M.2 PCIe Gen3x4 2280 Internal SSD
- 256GB NVMe M.2 PCIe Gen3x4 2280 Internal SSD
- 512GB NVMe M.2 PCIe Gen3x4 2280 Internal SSD

*Certification is ongoing

reComputer J30 series

NEW

Product Name **reComputer J3010/ J3011**

Module Embedded Jetson Orin Nano 4GB/ 8GB

Dimensions 130mm x120mm x 58.5mm

SKU [110110146](#) / [110110147](#)

Certification 



Introduction reComputer J30 series consist of hand-size edge AI boxes built with Jetson Orin™ Nano 4GB and 8GB modules which deliver up to 20 TOPS and 40 TOPS AI performance and has a rich set of IOs including USB 3.2 ports(4x), HDMI 2.1, M.2 key E for WIFI, M.2 Key M for SSD, RTC, CAN, Raspberry Pi GPIO 40-pin and more. It is also equipped with an aluminum case, cooling fan with a heatsink and a pre-installed JetPack System. As part of the NVIDIA Jetson ecosystem, reComputer J30 series is ready for your next AI application development and deployment.

Features

- Cooling Fan
- M.2 Key E
- M.2 Key M
- Pre-installed JetPack 5.1
- 128GB NVMe SSD
- 1x RJ45 for GbE
- 4x USB3.2
- Wi-Fi/Bluetooth

Applications



reComputer J3010 Orin Nano 4GB  **20TOPS**
 reComputer J3011 Orin Nano 8GB  **40TOPS**

Price from: **\$499**

reComputer J40 series

NEW

Product Name [reComputer J4011/ J4012](#)

Module Embedded Jetson Orin NX 8GB/16GB

Dimensions 130mm x120mm x 58.5mm

SKU [110110144](#) / [110110145](#)

Certification 

Introduction reComputer J40 series consist of hand-size edge AI boxes built with Jetson Orin™ NX 8GB and 16GB modules which deliver up to 70 TOPS and 100 TOPS AI performance and has a rich set of IOs including USB 3.2 ports(4x), HDMI 2.1, M.2 key E for Wi-Fi, M.2 Key M for SSD, RTC, CAN, Raspberry Pi GPIO 40-pin and more. It is also equipped with an aluminum case, a cooling fan with a heatsink, and a pre-installed JetPack System. As part of the NVIDIA Jetson ecosystem, reComputer J40 series is ready for your next AI application development and deployment.

Features

Cooling Fan

M.2 Key E

M.2 Key M

Pre-installed JetPack 5.1

128GB NVMe SSD

1x RJ45 for GbE

4x USB3.2

Applications



reComputer J4011 Orin NX 8GB

70TOPS

reComputer J4012 Orin NX 16GB

100TOPS

Price from: **\$699**

reComputer Industrial Series NEW

Product Name	reComputer Industrial J20 / J30 / J40
Dimensions	170mm x 100mm
Module Compatibility	- Jetson Xavier NX - Jetson Orin NX - Jetson Orin Nano
SKU	110110188 / 110110189 / 110110192 / 110110193 / 110110190 / 110110191
Certification	

Introduction reComputer Industrial series are the edge AI computers based on NVIDIA Jetson modules. It is suitable for the application deployment of edge AI inferencing and processing in complex field environment. Support Nvidia Jetson Xavier NX, Nano, Orin NX, Orin Nano versions.

Features

- Pre-installed Jetpack 5.1
- Fanless Design
- 3x USB3.2
- PoE
- RS232/422/485
- 1xCAN
- NVMe M.2
- Dual GbE

Applications

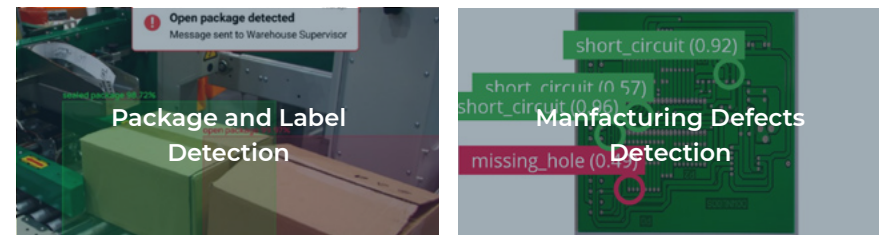

- J20 Xavier NX 21TOPS
- J30 Orin Nano 40TOPS
- J40 Orin NX 100TOPS

Price from: \$999

Release Date: 2023.Q2

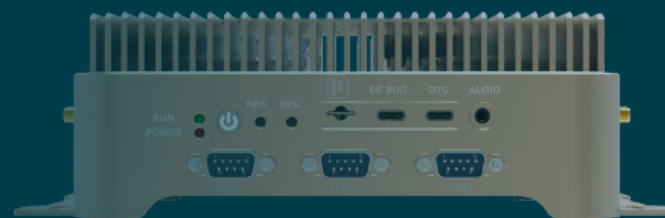

NVIDIA Jetson Modules Embedded Mini PCs

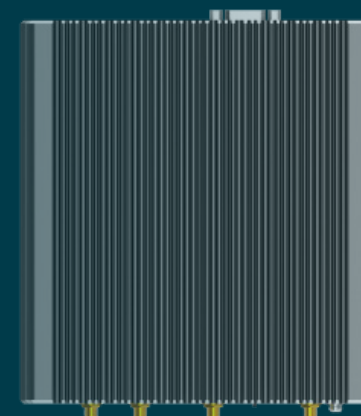

AGX Orin / AGX Xavier / Xavier NX SoM

Pre-installed Jetpack

AIoT

AGX Orin - Industrial

Product Name	Mini AI Computer T906
Module Embedded	Jetson AGX Orin 32GB
Dimensions	196.7mmx196mmx74mm
SKU	114110168

Introduction

Mini AI Computer T906 is powered by Jetson AGX Orin 32GB Module, delivers up to 200TOPS AI performance, and is equipped with two Ethernet ports for up to 10 Gbps networking. Supports Wi-Fi, Bluetooth, 4G/5G, and GPS enables hybrid fast network and navigation. The full system is ideal for building energy-efficient autonomous machines with the most advanced AI power, and industrial interfaces, and operating under excellent passive heat dissipation, two fans, along with IP55 lightweight aluminum alloy structure.



Features

- Passive Cooling
- M.2 Key E
- M.2 Key M
- Pre-installed JetPack 5.0.2
- 3xCAN
- 3xRS-232
- 4xUSB3.0
- 10GbE
- 1GbE

Applications

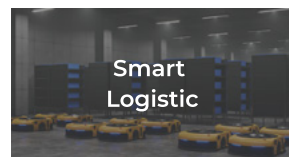
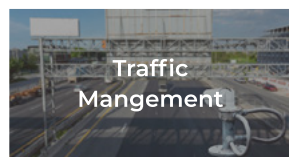

Jetson Xavier NX - Industrial

Product Name [Mini AI Computer T506S](#)

Module Embedded Jetson Xavier NX 8GB

Dimensions 155mm × 165mm × 52.5mm

SKU [114110167](#)

Introduction Mini AI Computer T506S is an edge AI platform, including 5x PoE Gigabit RJ45 ports, equipped with enhanced ability of video processing by Jetson Xavier NX 8GB, carrying 128GB SSD along with NVMe storage expandability, which represents an ideal solution for intelligent video analytics, traffic management, etc..

Features

Passive Cooling

5x PoE Gigabit RJ45

RS232/485

Pre-installed JetPack 4.6

128GB SSD

4xUSB3.0

Applications

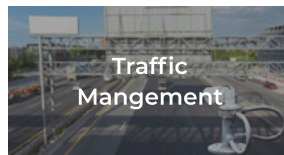

Jetson Xavier NX - Industrial NEW

Product Name	A205E Mini PC
Module Embedded	Jetson Xavier NX 8GB
Dimensions	209mm x 130mm x 66 mm
SKU	114110148

Introduction Designed for industrial use, A205-E Mini PC combines exceptional AI performance, and sufficient storage with a rich set of IOs— HDMI, USBs, RS485, RS232, CAN, I2Cs, and SPIs for AI-embedded industrial and functional safety applications in a power-efficient, small form factor. The passive thermal design that can meet industrial standards such as anti-vibration and anti-static. It supports operating range from -25°C to 80°C.

Features

- Passive Cooling
- Aluminum case
- RS232
- RS485
- Pre-installed JetPack 5.0.2
- 128GB NVME SSD
- Wi-Fi/Bluetooth
- 2x HDMI
- 4x USB3.0
- 2x GbE

Applications

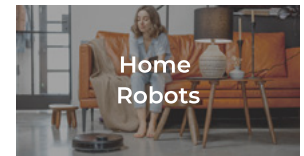
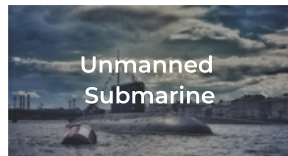
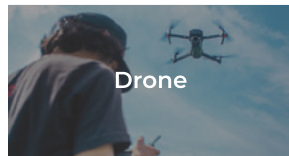

Jetson Xavier NX - Industrial

Product Name	A203 Mini PC
Module Embedded	Jetson Xavier NX 8GB
Dimensions	100mm x 50mm x 59mm
SKU	114110147

Introduction A203 Mini PC is a powerful and extremely small intelligent edge computer to bring modern AI to the edge. It has a smaller form factor compared to Jetson Xavier NX Developer Kit, and delivers same AI performance for up to 21 TOPS. For smart cities, security, industrial automation, smart factories, and other edge AI solution providers, A203 Industrial Mini PC combines exceptional AI performance, and sufficient storage with a rich set of IOs.

Features

- Ultra-small
- Aluminum case
- RS232
- 2xUSB3.0
- Pre-installed JetPack 5.0.2
- Wi-Fi/Bluetooth
- 2x HDMI



Applications

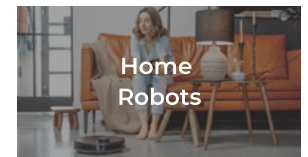
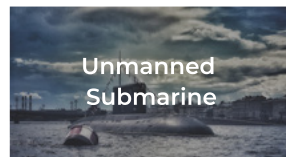
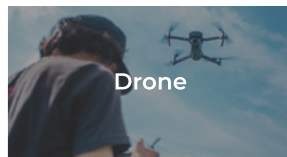

Jetson Xavier NX

Product Name	Jetson SUB Mini PC V2 - Blue
Module Embedded	Jetson Xavier NX
Dimensions	130mm x 120mm x 50mm
SKU	110061461

Introduction Jetson SUB Mini PC V2 is a hand-size edge AI box built with Jetson Xavier NX module which delivers up to 21 TOPS AI performance and equipped with a reComputer J202 carrier board. It is preinstalled with Jetpack 5.0.2, simplifies development, and fits for deployment for edge AI solution providers.

Features

- 1 x USB Type-C
- 128GB (M.2 key M) NVMe SSD
- Mounting hole design
- HDMI port + DP port
- Wi-Fi module and antenna
- 4 USB 3.1
- Removable acrylic cover
- NVIDIA JetPack 5.0.2

Applications



Jetson Xavier NX

Product Name	Jetson SUB Mini PC-Black
Module Embedded	Jetson Xavier NX
Dimensions	205mm x 130mm x 65mm
SKU	102110641

Introduction Consists of an NVIDIA® Jetson Xavier™ NX Module, a carrier board, and a fully sealed Aluminum case with pre-installed OLED.

Ideal for high-performance compute and AI in embedded and edge systems, especially in harsh environments.

Features

- Xavier NX Module
- 2 HDMI ports
- 256 GB (2.5-inch SATA) SSD
- 4 USB 3.1 Type-A ports
- Wi-Fi module and antenna
- OLED screen
- Passive Cooling
- NVIDIA JetPack software 4.6

Applications

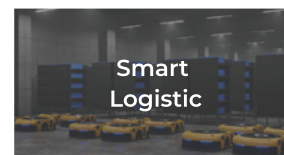
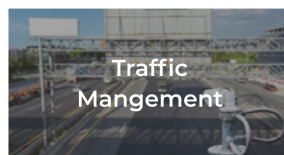

Jetson Xavier NX

Product Name [Jetson SUB Mini PC-Silver](#)

Module Embedded Jetson Xavier NX

Dimensions 130mm x 90mm x 60mm

SKU [102110642](#)

Introduction Consists of an NVIDIA® Jetson Xavier™ NX Module, a carrier board, a quiet cooling fan, and a whole oval aluminum enclosure. Tiny and portable, ideal for high-performance compute and AI in embedded and edge systems in office/home or outdoor.

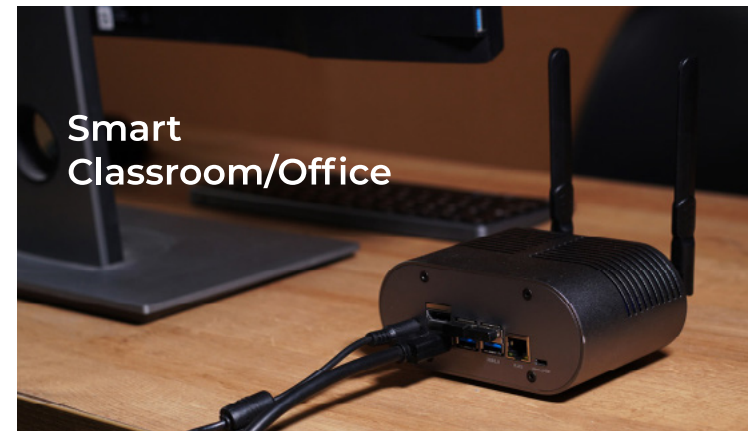
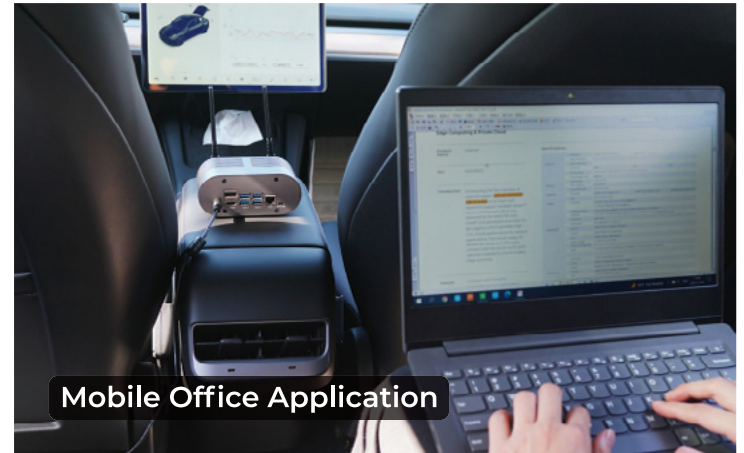

Features

Xavier NX Module

Wi-Fi module and antenna

4 USB 3.1 Type-A ports

HDMI port + DP port

NVIDIA JetPack software 4.6

128GB (M.2 key M) SSD

Applications

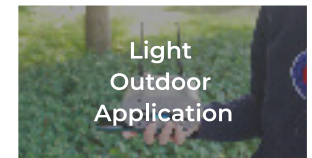
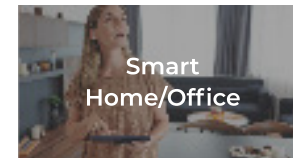
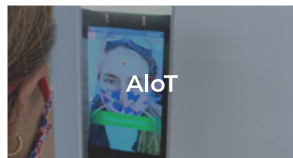

Jetson AGX Xavier

Product Name	Jetson AGX Xavier H01 Kit
Module Embedded	Jetson AGX Xavier 32GB
Dimensions	130mm x 105mm x 77mm
SKU	110991666

Introduction Consists of an NVIDIA® Jetson AGX Xavier 32GB production version module, a carrier board, a cooling fan, and an aluminum case.

Ideal for development and deployment of end-to-end AI robotics applications.

Features

- AGX Xavier 32GB Module
- 1 x HDMI 2.0 (TYPE A)
- TF Card Slot
- Pre-installed WiFi
- 2 x USB 3.0 Type A
- 1 x M.2 Key M (NVMe SSD)
- NVIDIA Jetpack software 4.6

Applications

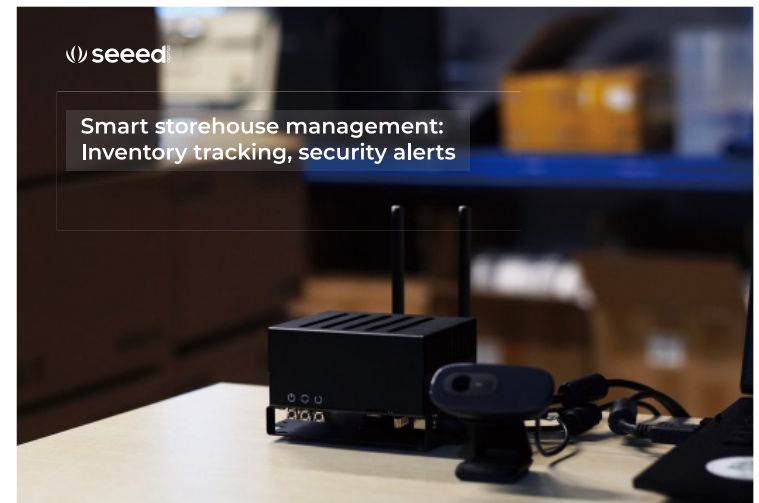
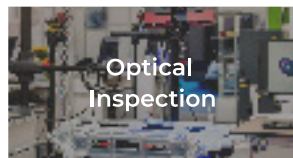

reServer for NVIDIA Jetson

Inference center for the edge



Local Intelligent Video Analytics

Jetson Xavier NX/ Orin NX/ Orin Nano

Pre-installed Jetpack

5 GbE

2.5 inches 256GB SSD

PoE

reServer Jetson

- Compact design: Edge AI server with an overall dimension of 132mm*124mm*233mm.
- Powerful AI module: NVIDIA® Jetson Xavier™ NX 16GB.
- Fast network access: 2.5GbE port, 1GbE port x1.
- Hybrid connectivity: Support 5G, 4G, LoRaWAN (modules not included).
- Rich peripherals: HDMI 2.0 x1, DP1.4 x1, USB3.1 GEN2 (up to 10Gbit) x2.
- Expandable storage: Dual SATA III data connectors for 3.5"/2.5" SATA hard disk drives.
- Work as stable intelligent NVR system: pre-installed 2.5 inches 256GB SSD *1 and Jetpack, support entire Jetson software.

Certification*



reServer J2032

- Xavier NX 16GB Module
- Support 2 x 2.5"/3.5" SATA (HDD/SSD), up to SATA3

SKU: [110061403](#)

- reServer for Orin NX(In development)

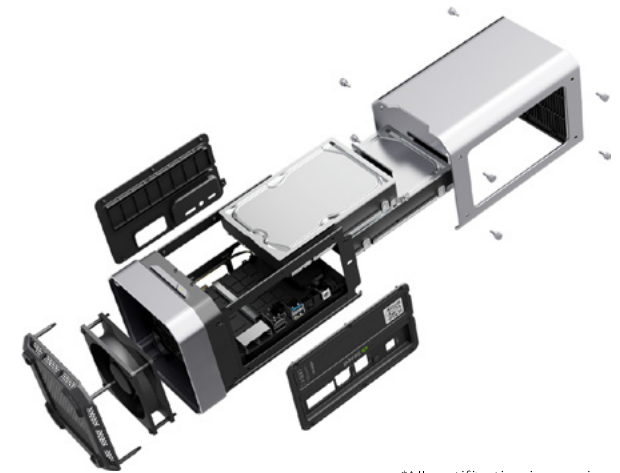

*All certification is ongoing

reServer J30 series

NEW

Local inference center for video intelligences

Product Name **reServer Industrial J3010/J3011**

Module Embedded Jetson Orin Nano 4GB/ 8GB

Dimensions 194.33mm x 187mm x 95.5mm

SKU [114110250](#) / [114110249](#)

Certification 

Introduction reServer Industrial J30 series bring AI-enabled NVR to the edge and features NVIDIA Jetson Orin™ Nano for up to 40 TOPS AI performance, has a fanless design, expandable storage, versatile mounting options, and allows multiple streaming deployment for more harsh environments and heavier loads. Upgrade legacy cameras effortlessly with the reServer, which can also perform on-site video analytics tasks, reducing the need for constant human monitoring. With two 2.5-inch hard drive bays, the reServer Industrial provides ample storage capacity, ensuring you have the space needed for expanding data requirements.

Features

5 RJ45 GbE

4 PoE Video Input

2 Drive bays for 2.5" HDD/SSD

1 RS232/RS422/RS485

4 DI/DO

1 CAN

Applications



reServer Industrial J3010 Orin Nano 4GB  **20TOPS**

reServer Industrial J3011 Orin Nano 8GB  **40TOPS**

Price from: **\$899**

reServer J40 series

NEW

Local inference center for video intelligences

Product Name **reServer Industrial J4011/J4012**

Module Embedded Jetson Orin NX 8GB/16GB

Dimensions 194.33mm x 187mm x 95.5mm

SKU [114110248](#) / [114110247](#)

Certification 

Introduction reServer Industrial J40 series bring AI-enabled NVR to the edge and features NVIDIA Jetson Orin™ NX for up to 100 TOPS AI performance, has a fanless design, expandable storage, versatile mounting options, and allows multiple streaming deployment for more harsh environments and heavier loads. Upgrade legacy cameras effortlessly with the reServer, which can also perform on-site video analytics tasks, reducing the need for constant human monitoring. With two 2.5-inch hard drive bays, the reServer Industrial provides ample storage capacity, ensuring you have the space needed for expanding data requirements.

Features

5 RJ45 GbE

4 PoE Video Input

2 Drive bays for 2.5" HDD/SSD

1 RS232/RS422/RS485

4 DI/DO

1 CAN

Applications



reServer Industrial J4011 Orin Nano 8GB



70TOPS

reServer Industrial J4012 Orin Nano 16GB





100TOPS

Price from: **\$1099**





Jetson Nano full system comparison

Production Module	Jetson Nano		
			
Product Name	reComputer J1010	reComputer J1020 v2	NVIDIA® Jetson Nano Developer Kit-B01
SKU	110061362	110061441	102110417
AI Performance	472 GFLOPS		
GPU	NVIDIA Maxwell™ architecture with 128 NVIDIA CUDA® cores		
CPU	NVIDIA Quad-core Arm® Cortex®-A57 MPCore processor		
Memory	4 GB 64-bit LPDDR4, 1600MHz 25.6 GB/s		
Storage	16 GB eMMC 5.1	16 GB eMMC 5.1 1*M.2 Key M connector	microSD slot
Video Encode	1*4K30 2*1080p60 4*1080p30 4* 720p60 9* 720p30 (H.265/H.264)		1*4K30 4*1080p30 9*720p30 (H.264/H.265)
Video Decode	1*4K60 2*4K30 4*1080p60 8*1080p30 9*720p60 (H.265/H.264)		1*4K60 2*4K30 8*1080p30 18*720p30 (H.264/H.265)
Networking	1*RJ45 Gigabit Ethernet Connector (10/00/1000)		
USB	1*USB 3.0 Type A 2*USB 2.0 Type A 1*USB Type-C for device mode 1*USB Type-C for 5V power input	4*USB 3.0 Type-A 1*USB Type-C for device mode	4*USB 3.0 Type-A 1*USB 2.0 Micro-B for device mode
CSI Camera	2*CSI camera connectors (15 pos, 1mm pitch, MIPI CSI-2)		
Display	1*HDMI 2.0 Type A	1*HDMI 2.0 Type A 1*DP	1*HDMI 2.0 Type A 1*DP
Fan	1*Fan Connector(5V PWM)		
M.2 Key E	1*M.2 Key E connector to support WiFi/BT	1*M.2 Key E (disabled)	1*M.2 Key E connector to support WiFi/BT
Multifunctional header	1*40-Pin header (GPIO, I2C, I2S, SPI, UART)		
Power Adapter	USB Type-C 5V/3A	DC Barrel Jack 12V/2A	DC Barrel Jack 5V/4A Micro-USB 5V/2A
Power	5W 10W		
Dimensions	130mmx120mmx50mm (with case)	130mmx120mmx50mm(with case)	100mmx80mmx29mm



Jetson Xavier NX full system comparison

Production Module	Jetson Xavier NX					
						
Product Name	reComputer J2021	reComputer J2022	reComputer Industrial J2011	reComputer Industrial J2012	reServer J2032	Jetson Sub V2 - Blue
SKU	110061381	110061402	110110188	110110189	110061403	110061461
AI Performance	21 TOPS					
GPU	384-core NVIDIA Volta™ GPU with 48 Tensor Cores					
CPU	6-core NVIDIA Carmel ARM® v8.2 64-bit CPU, 6MB L2 + 4MB L3					
Memory	8 GB 128-bit LPDDR4 x 59.7GB/s	16 GB 128-bit LPDDR4x 59.7GB/s	8GB 128-bit LPDDR4 x 59.7GB/s	16GB 128-bit LPDDR4 x 59.7GB/s	16 GB 128-bit LPDDR4x 59.7GB/s	8 GB 128-bit LPDDR4x 59.7GB/s
Storage	16 GB eMMC 5.1 1*M.2 Key M connector		16GB eMMC 5.1, M.2 Key M PCIe Gen4.0 SSD (M.2 NVMe 2280 SSD 128G included)		16 GB eMMC 5.1 256GB SATA III SSD 2* SATA III data connectors 2* SATA III power connectors	16 GB eMMC 5.1 128GB M.2 NVMe SSD
Video Encode	2*4K60 4*4K30 10*1080p60 22*1080p30 (H.265); 2*4K60 4*4K30 10*1080p60 20*108p30 (H.264)					
Video Decode	2*8K30 6*4K60 12*4K30 22*1080p60 44*1080p30 (H.265); 2*4K60 6*4K30 10*1080p60 22*1080p30 (H.264)					
Networking	1*RJ45 Gigabit Ethernet Connector (10/100/1000)		1* LAN1 RJ45 GbE PoE(PSE 802.3 af 15 W) 1* LAN2 RJ45 GbE (10/100/1000Mbps) Optional WiFi/Bluetooth module support		1*RJ45 GbE; 1*RJ45 2.5GbE 1*M.2 Key B connector to support 5G/4G 1*Mini PCIe connector to support LoRa/ Series wireless; 1*Sim card slot	1*RJ45 Gigabit Ethernet Connector (10/100/1000)
USB	4*USB 3.1 Type A Connector; 1*USB Type-C for device mode		3* USB3.2 Gen1, 1* USB2.0 Type C(Device mode), 1* USB2.0 Type C For Debug UART & RP2040		2*USB 3.1 Gen 2 Type A connector 1*USB Type-C for device mode 1*USB Type-C for RP2040 Coprocessor	4*USB3.1(USB 2.0 Integrated) 1*USB Type-C
CSI Camera	2*CSI camera connectors (15 pos, 1mm pitch, MIPI CSI-2)		2*CSI (2-lane 15pin)		-	2* CSI (2-lane 15pin)
Display	1*HDMI 2.0 Type A; 1*DP		1*HDMI 2.0 Type A		1*HDMI 2.0 Type A; 1*DP1.4	1*HDMI 2.0 Type A; 1*DP
Fan	1*Fan (5V PWM)		Fanless, passive heatsink; 1*Fan connectors(5V PWM)		1*Jetson Xavier NX Fan (5V PWM) 1* Main Fan (12V)	1*Fan (5V PWM)
M.2	1*M.2 Key E connector to support WiFi/BT		M.2 Key B support 4G/5G (Module optional)		-	1*M.2 Key E connector to support WiFi/BT (module included)
Mini PCIe	-		1* Mini PCIe for 4G/LoRa		-	-
Multifunctional header/ IO	1*40-Pin header (GPIO, I2C, I2S, SPI, UART)		DI/DO/CAN/RS232, RS422 and RS485/TPM 2.0 header		-	1*40-Pin header (GPIO, I2C, I2S, SPI, UART)
Power Adapter	DC Barrel Jack 12V/5A (5.5/2.1mm)		19V Power Adapter(without power cord)		DC Barrel Jack 12V @5A	DC Barrel Jack 12V/5A
Dimensions	130mmx120mmx50mm (with case)		159mm x 155mm x 57mm		132mmx124mmx233mm (with case)	130mm x 120mm x 50mm (with case)



Jetson Xavier NX full system comparison

Production Module	Jetson Xavier NX			
				
Product Name	A203	A205 E	T506S	Jetson Sub Black
SKU	114110147	114110148	114110167	102110641
AI Performance	21 TOPS			
GPU	384-core NVIDIA Volta™ GPU with 48 Tensor Cores			
CPU	6-core NVIDIA Carmel ARM® v8.2 64-bit CPU, 6MB L2 + 4MB L3			
Networking	1*RJ45 GbE (10/100/1000) 1*Sim card slot	1*RJ45 GbE (10/100/1000) 1*WiFi/ BLE module	4*PoE(PSE) GbE Ports 1*PoE(PD) GbE Port	2*RJ45 GbE (10/100/1000) 1*WiFi module
Memory	8 GB 128-bit LPDDR4x 59.7GB/s			
USB	2*USB3.0 Type A 1*USB 2.0 Micro-B for device mode	4*USB 3.0 Type A 1*USB 2.0 Type C for device mode	4*USB 3.0 Type A 1*USB 2.0 Micro-B (OTG) for device mode	4*USB 3.0 Type-A (Integrated USB 2.0) 1*USB 2.0 Micro-B (OTG) for device mode
Camera	1*CSI camera connector (15 pos, 1mm pitch, MIPI CSI-2)	MIPI connector compatible with MIPI CSI and GMSL	-	6*camera connectors (15 pos, 1mm pitch, MIPI CSI-2)
Display	1*HDMI 2.0 Type A	2*HDMI 2.0 Type A	1*HDMI 2.0 Type A	2*HDMI 2.0 Type A
M.2 Key E	1*M.2 Key E connector to support WiFi/ BT (module included)	-	1*M.2 Key E connector to support 5G	1*M.2 Key E connector
mini PCIe	/	/	1*Mini PCIe connector to support 4G	/
IO	1*RS232, 1*CAN, 2*SPI, 2*I2C Link(+3.3V I/ O), 5*GPIO, 1*I2S(3.3V Level)	1*RS485, 1*RS232, 1*CAN, 1*SPI Bus(+3.3V Level), 2*I2C Link(+3.3V I/O), 1*GPIO	1*RS485, 1*RS232, 1*CAN 2.0b, 1*I2C, 4*GPIO	1*UART, 1*CAN, 2*SPI Bus(+3.3V Level), 2*I2C Link(+3.3V I/O), 2*GPIO
Multifunctional header	1*40-Pin header (GPIO, I2C, I2S, SPI, UART)	/	/	1*40-Pin header (GPIO, I2C, I2S, SPI, UART, CAN)
FAN	1* Fan (5V PWM)	Fanless, passive heatsink	Fanless, passive heatsink	Fanless, passive heatsink
Power Input	9V - 19V DC	9V - 36V DC	12-36V DC	13-20V DC
Power Adapter	DC 19V 4.74A (MAX 90W)	DC Jack 19V 4.74A (MAX 90W)	DC Jack 19V 3.42A	DC Jack 19V 4.74A (MAX 90W)
Dimensions	100mm x 50mm x 59mm (with case)	209mm x 130mm x 66 mm (with case)	155mm x 165mm x 52.5mm (with case)	205mm x 130mm x 65mm (with case)
Operating temperature	-20°C~ 80°C, 0.2~0.3m/s air flow	-20°C~ 65°C, 0.2 ~ 0.3m/s air flow	-20°C ~ 65°C	-25°C ~ +80°C
Operating System	Pre-installed JetPack 5.0.2	Pre-installed JetPack 5.0.2	Pre-installed JetPack 4.6	Pre-installed JetPack 4.6



Jetson AGX Xavier full system comparison

Production Module	Jetson AGX Xavier	
		
Product Name	Jetson AGX Xavier H01 Kit	NVIDIA® Jetson AGX Xavier Developer Kit
SKU	110991666	102110406
AI Performance	32TOPS	
GPU	NVIDIA Volta™ architecture 512 NVIDIA CUDA® and 64 Tensor cores	
CPU	8-core NVIDIA Carmel Arm® v8.2 64-bit CPU 8MB L2 + 4MB L3	
Memory	32 GB 256-bit LPDDR4x 136.5GB/s	
Storage	32 GB eMMC 5.1 SD/UFS and microSD card slot; 1*M.2 Key M connector	32 GB eMMC 5.1; microSD card slot eSATA port; 1*M.2 Key M connector
Video Encode	4*4K60 8*4K30 16*1080p60 32* 1080p30 (H.265) 30*1080p30 (H.264)	2*4K60 HEVC / (2x) 4K60 12-Bit Support
Video Decode	2*8K30 6*4K60 12*4K30 26* 1080p60 52*1080p30 (H.265) 30*1080p30 (H.264)	2*4K60 HEVC / (2x) 4K60 12-Bit Support
Networking	1*RJ45 Gigabit Ethernet Connector (10/100/1000)	
USB	2*USB 3.0 Type-A; 1*USB 2.0 Type-C for device mode	1*USB 3.1 Type-A; 1*USB Type-C for device mode/ debug; 1*USB Type-C; 1*USB 2.0 Micro-B for debug
Camera	Camera connector(Compatible with MIPI CSI and GMSL)	
Display	1x HDMI2.0 Type A	
Fan	1*12V Fan	
M.2 Key E	1*M.2 Key E connector	
PCIe	PCIe X16 (x8 PCIe Gen4 / x8 SLVS-EC)	
Multifunctional header	1*40 Pin header	
Power Adapter	DC Jack 19V 4.74A (MAX 90W)	
Power	10W 15W 30W	
Dimensions	130mmx105mmx77mm(with case)	105mmx105mmx65mm

Jetson Orin full system comparison

Production Module	Jetson Orin Nano				Jetson Orin NX				Jetson AGX Orin
									
Product Name	reComputer J3010	reComputer J3011	reComputer Industrial J3010	reComputer Industrial J3011	reComputer J4011	reComputer J4012	reComputer Industrial J4011	reComputer Industrial J4012	Mini AI Computer T906
SKU	11010146	11010147	11010192	11010193	11010144	11010145	11010190	11010191	11410168
Module	Jetson Orin Nano 4GB	Jetson Orin Nano 8GB	Jetson Orin Nano 4GB	Jetson Orin Nano 8GB	Jetson Orin NX 8GB	Jetson Orin NX 16GB	Jetson Orin NX 8GB	Jetson Orin NX 16GB	Jetson AGX Orin 32GB
AI Performance	20 TOPS	40 TOPS	20TOPS	40TOPS	70 TOPS	100 TOPS	70TOPS	100TOPS	200 TOPS
GPU	512-core NVIDIA Ampere architecture GPU with 16 Tensor Cores	1024-core NVIDIA Ampere architecture GPU with 32 Tensor Cores	512-core NVIDIA Ampere architecture GPU with 16 Tensor Cores	1024-core NVIDIA Ampere architecture GPU with 32 Tensor Cores	NVIDIA Ampere architecture with 1024 NVIDIA® CUDA® cores and 32 tensor cores		1024-core NVIDIA Ampere architecture GPU with 32 Tensor Cores		1792-core NVIDIA Ampere architecture GPU with 56 Tensor Cores
CPU	6-core Arm® Cortex®-A78AE v8.2 64-bit CPU 1.5MB L2 + 4MB L3; 8-core Arm® Cortex®-A78AE v8.2 64-bit CPU 2MB L2 + 4MB L3		6-core Arm® Cortex®-A78AE v8.2 64-bit CPU 1.5MB L2 + 4MB L3		6-core Arm® Cortex®-A78AE v8.2 64-bit CPU 1.5MB L2 + 4MB L3	8-core Arm® Cortex®-A78AE v8.2 64-bit CPU 2MB L2 + 4MB L3	6-core Arm® Cortex®-A78AE v8.2 64-bit CPU 1.5MB L2 + 4MB L3	8-core Arm® Cortex®-A78AE v8.2 64-bit CPU 2MB L2 + 4MB L3	8-core Arm® Cortex®-A78AE v8.2 64-bit CPU 2MB L2 + 4MB L3
Memory	4GB 64-bit LPDDR5 34 GB/s	8GB 128-bit LPDDR5 68 GB/s	4GB 64-bit LPDDR5 34 GB/s	8GB 128-bit LPDDR5 68 GB/s	8GB 128-bit LPDDR5 102.4 GB/s	16GB 128-bit LPDDR5 102.4 GB/s	8GB 128-bit LPDDR5 102.4 GB/s	16GB 128-bit LPDDR5 102.4 GB/s	32GB 256-bit LPDDR5 204.8 GB/s
Storage	1*M.2 Key M (128GB NVMe SSD included)		M.2 Key M PCIe Gen4.0 SSD (M.2 NVMe 2280 SSD 128G included)		1*M.2 Key M (128GB NVMe SSD included)		M.2 Key M PCIe Gen4.0 SSD (M.2 NVMe 2280 SSD 128G included)		64GB eMMC 5.1 1*M.2 Key M connector
Video Encode	1080p30 supported by 1-2 CPU cores		1080p30 supported by 1-2 CPU cores		1*4K60 3*4K30 6*1080p60 12*1080p30 (H.265) H.264, H.265, AV1		1*4K60 (H.265) 3*4K30 (H.265) 6*1080p60 (H.265) 12*1080p30 (H.265)		1*4K60 3*4K30 6*1080p60 12*1080p30 (H.265)
Video Decode	1x 4K60 2x 4K30 5x 1080p60 11x 1080p30 (H.265)		1*4K60 (H.265) 2*4K30 (H.265) 5*1080p60 (H.265) 11*1080p30 (H.265)		1*8K30 2*4K60 4*4K30 9*1080p60 18*1080p30 (H.265) H.264, H.265, VP9, AV1		1*8K30 (H.265) 2*4K60 (H.265) 4*4K30 (H.265) 9*1080p60 (H.265) 18*1080p30 (H.265)		1*8K30 2*4K60 4*4K30 9*1080p60 18*1080p30 (H.265) H.264, H.265, VP9, AV1
Networking	1*RJ45 Gigabit Ethernet Connector (10/100/1000)		1* LAN1 RJ45 GbE PoE(PSE 802.3 af 15 W) 1* LAN2 RJ45 GbE (10/100/1000Mbps)Optional WiFi/Bluetooth module support		1*RJ45 Gigabit Ethernet Connector (10/100/1000)		1* LAN1 RJ45 GbE PoE(PSE 802.3 af 15 W) 1* LAN2 RJ45 GbE (10/100/1000Mbps)Optional WiFi/Bluetooth module support		1*RJ45 GbE (10/100/1000) 1*RJ45 10GbE 1*M.2 Key B connector for WiFi 1*Sim card slot; 1*GPS module
USB	4*USB 3.2 Type-A 1*USB Type C for device mode		3* USB3.2 Gen1, 1* USB2.0 Type C(Device mode), 1* USB2.0 Type C For Debug UART & RP2040		4*USB 3.2 Type-A 1*USB Type C for device mode		3* USB3.2 Gen1, 1* USB2.0 Type C(Device mode), 1* USB2.0 Type C For Debug UART & RP2040		4*USB 3.0 Type A 1*USB 2.0 Type-C for device mode 1*USB 2.0 Type-C for debug
Camera	2*CSI Cameras (15 pos, 1mm pitch, MIPI CSI-2)		2* CSI (2-lane 15pin)		2*CSI Cameras (15 pos, 1mm pitch, MIPI CSI-2)		2* CSI (2-lane 15pin)		GMSL 2 camera connector (compatible with GMSL1)
Display	1*HDMI		1*HDMI 2.0 Type A		1*HDMI		1*HDMI 2.0 Type A		1*HDMI 2.0 Type-A
Fan	1* Fan(5V PWM) (Fan included)		Fanless, passive heatsink		1* Fan(5V PWM) (Fan included)		Fanless, passive heatsink		2* Fan(5V PWM)
M.2	1*M.2 Key E (WiFi/Bluetooth included)		M.2 Key B support 4G/5G (Module optional)		1*M.2 Key E		M.2 Key B support 4G/5G (Module optional)		1*M.2 Key E
Mini PCIe	/		1* Mini PCIe for 4G/Lora		/		1* Mini PCIe for 4G/Lora		1*Mini PCIe connector for 4G
Multifunctional header / IO	1*40-Pin header		DI/DO/CAN/RS232, RS422 and RS485/TPM 2.0 header		1*40-Pin header		DI/DO/CAN/RS232, RS422 and RS485/TPM 2.0 header		3*CAN (with CAN chip) 2*GPIO 2*RS-232 D-SUB9 1*RS232 for time sync
Power	7W - 10W	7W - 15W	7W - 10W	7W - 15W	10W - 20W	10W - 25W	10W - 20W	10W - 25W	15W - 40W
Power Adapter	DC Jack 12V 5A		19V Power Adapter(without power cord)		DC Jack 12V 5A		19V Power Adapter(without power cord)		DC Jack 19V 4.74A
Dimensions	130mmx120mmx50mm (with case)		159mm x 155mm x 57mm		130mmx120mmx50mm (with case)		159mm x 155mm x 57mm		196.7mmx196mmx74mm

Jetson Orin full system comparison

Production Module	Jetson Orin Nano		Jetson Orin NX	
				
Product Name	reServer Industrial J3010	reServer Industrial J3011	reServer Industrial J4011	reServer Industrial J4012
SKU	114110250	114110249	114110248	114110247
Module	Jetson Orin Nano 4GB	Jetson Orin Nano 8GB	Jetson Orin NX 8GB	Jetson Orin NX 16GB
AI Performance	20 TOPS	40 TOPS	70 TOPS	100 TOPS
GPU	512-core NVIDIA Ampere architecture GPU with 16 Tensor Cores	1024-core NVIDIA Ampere architecture GPU with 32 Tensor Cores		
CPU	6-core Arm® Cortex®-A78AE v8.2 64-bit CPU			8-core Arm® Cortex®-A78AE v8.2 64-bit CPU 2MB L2 + 4MB L3
Memory	4GB 64-bit LPDDR5 34 GB/s	8GB 128-bit LPDDR5 68 GB/s	8GB 128-bit LPDDR5 102.4GB/s	16GB 128-bit LPDDR5 102.4GB/s
Storage	M.2 Key M (2280) PCIe Gen4.0 SSD (M.2 NVMe SSD 128G included)			
Video Encode	1080p30 supported by 1-2 CPU cores		Standards supported: H.265 (HEVC), H.264, AV1 1*4K60 (H.265) 3*4K30 (H.265) 6*1080p60 (H.265) 12*1080p30 (H.265)	
Video Decode	Standards supported: H.265 (HEVC), H.264, VP9, AV1 1*4K60 (H.265) 2*4K30 (H.265) 5*1080p60 (H.265) 11*1080p30 (H.265)		Standards supported: H.265 (HEVC), H.264, VP9, AV1 1*8K30 (H.265) 2*4K60 (H.265) 4*4K30 (H.265) 9*1080p60 (H.265) 18*1080p30 (H.265)	
Networking	1* LAN0 RJ45 GbE (10/100/1000Mbps); 4* LAN RJ45 GbE PoE(PSE 802.3 af 15 W, 10/100/1000Mbps)			
USB	4* USB3.2, 1* USB2.0 Type C(Device mode), 1* USB2.0 Type C For Debug UART & RP2040			
Display	1*HDMI 1.4 Type A 3840x2160 at 30 Hz		1*HDMI 2.1 Type A 7680x4320 at 30 Hz	
Fan	Fanless, passive heatsink; 1*Fan connectors(5V PWM)			
M.2 Key B	M.2 Key B (3042/3052) support 4G/5G (Module optional)			
Mini PCIe	Mini PCIe for LoRaWAN®/4G/5G Series Wireless (Module optional)			
Multifunctional header / IO	2 Drive Bays to support 2.5" SATA HDD/SSD(SATA III 6.0Gbps); 1* Nano SIM card slot 4*DI,4*DO,3*GND_DI,2*GND_DO,1*GND_ISO,1*CAN; 1* DB9 (RS232/RS422/RS485)			
Power Adapter	19V Power Adapter(Without power cord)			
Dimensions	194.33mm x 187mm x 95.5mm			

Powerful Edge AI selection guide



NVIDIA Jetson Compatible Accessories

Heatsink, Case, Camera, and RPLiDAR

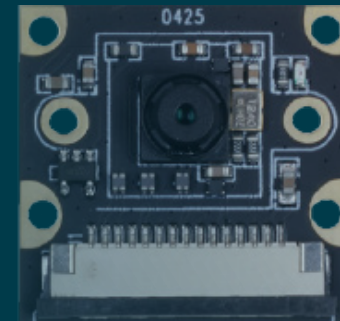

Accessory – Camera

Product Name NVIDIA Jetson module compatible camera

Introduction By using one of these cameras, combined with a Jetson Nano/ Xavier NX Development Kits, you can simply realize machine vision projects. Also, you can experience better quality video capture from these cameras and build more demanding projects. Some of them also has two IR LEDs to enable night vision capabilities.



High Quality Camera for Raspberry Pi CM3/ CM3 Lite/ CM3+/ CM3+ Lite & Jetson Nano with 12.3MP IMX477 Sensor
SKU [114992442](#)



IMX219-200 8MP Camera with 200° FOV
SKU [114992265](#)



IMX219-77IR 8MP IR Night Vision Camera with 77° FOV
SKU [114992261](#)



IMX219-77 8MP Camera with 77° FOV
SKU [114992260](#)



IMX219-160 8MP Camera with 160° FOV
SKU [114992263](#)



IMX219-130 8MP Camera with 130° FOV
SKU [114992262](#)



IMX219-83 8MP 3D Stereo Camera Module
SKU [114992270](#)



IMX219-160IR 8MP Camera with 160° FOV
SKU [114992264](#)

Accessory – Camera

Product Name e-con Systems cameras compatible with Seeed Jetson carrier boards

Introduction e-con Systems is an elite partner of NVIDIA and has been working with multiple NVIDIA solution providers to offer our customers complete vision solutions. In this pursuit, we have joined hands with Seeed Studio - an IoT hardware enabler that aims to be the most integrated platform for global creative technologists to turn ideas into products.

Some of the key features of e-con's cameras that can be evaluated with Seeed's carrier boards include high resolution (up to 13MP), global shutter & rolling shutter, low noise, excellent low light performance, and superior NIR sensitivity. By using the combination of e-con cameras and Seeed's carrier boards, product developers can reduce prototyping time and time to market by up to 40%.



e-CAM131_CUNX -
 4K Camera for NVIDIA® Jetson Xavier™
 NX/NVIDIA® Jetson Nano™



e-CAM81_CUNX -
 4K HDR Camera for NVIDIA® Jetson Xavier™
 NX / TX2 NX / Nano



e-CAM80_CUNX -
 Sony 4K Camera for NVIDIA® Jetson
 Xavier™ NX/Nano



e-CAM50_CUNX -
 5.0 MP NVIDIA® Jetson Xavier™
 NX/NVIDIA® Jetson Nano™ Camera



e-CAM24_CUNX -
 Color Global shutter Camera for,NVIDIA® Jetson
 Xavier™ NX / TX2 NX / Nano

Learn more at e-con Systems: www.e-consystems.com/seedstudio-cameras.aso

Accessory - RPLiDAR

Product Name

RPLiDAR - Laser Ranging Radar

Introduction

A low-cost two-dimensional laser ranging radar (LiDAR) can perform a 360-degree omni-directional laser ranging scan within certain radius of a two-dimensional plane, and thus can generate a flat point cloud map of the space in which it is located. These cloud map information can be used in practical applications such as mapping, robot positioning and navigation, and object/environment modeling.



RPLiDAR 1M8-R6 360 Degree Laser Scanner Kit- 12M Range

SKU [114992561](#)



Slamtec Mapper M1M1 ToF Laser Scanner Kit- 20M Range

SKU [114991984](#)



RPLiDAR 2M8 360 Degree Laser Scanner Kit- 12M Range

SKU [110991066](#)



RPLiDAR 2M6 360 Degree Laser Scanner Kit- 18M Range

SKU [110991067](#)



RPLiDAR 3M13 60 Degree Laser Scanner Kit- 25M Range

SKU [110991068](#)



RPLiDAR 2L Low Cost 360 Degree Laser Range Scanner- 30M Range

SKU [114992738](#)



RPLiDAR 1 Portable ToF Laser Scanner Kit- 40M Range

SKU [114090021](#)



Slamtec Mapper M2M1 Pro- LiDAR Mapping Sensor (Industrial Grade)- 40M Range

SKU [101990641](#)



RPLiDAR A2M12 360 Degree Laser Scanner Kit - 12M Range

SKU [114110128](#)

Accessory – LiDAR & Camera

Product Name LiDAR & Camera

Introduction These sensors adopt ToF method to measure distance. Some of them when combined with a modulated light source, are capable of measuring distance and reflectivity with VGA resolution.



TFmini S LiDAR module - Short- Range ToF LIDAR Range Finder

SKU [101990620](#)



DepthEye S2 -H67°x V51° VGA Camera with Sony IMX556PLR DepthSense

SKU [101990866](#)



DepthEye Wide - H100° x V75° VGA ToF Camera with Sony IMX556PLR DepthSense™

SKU [114992563](#)



DepthEye Turbo - VGA ToF with Sony IMX556PLR DepthSense

SKU [114991967](#)



OakSense H60Q-QVGA resolution ToF camera

SKU [114992757](#)



OakSense H67V-VGA resolution TOF camera supported C++ and Python

SKU [114992753](#)

Accessory - Heatsink

Product Name NVIDIA Jetson module compatible aluminum heatsink

Introduction If you're designing any kind of computing application with the NVIDIA Jetson modules, you seriously can't do without a heatsink if you want to avoid overheating problems.

Seeed's aluminum heatsinks for NVIDIA Jetson Modules are an essential piece of equipment for keeping modules cool, improving both computing performance and reliability under heavy workloads to realize their true potential. Some of them consist of a fan to ensure cooling effect.



Aluminum Heatsink for Jetson Nano Module

SKU [114992686](#)



Jetson Nano Module Active Heat Sink

SKU [101110061](#)



Aluminum Heatsink with Fan for Jetson Xavier NX Module

SKU [114992687](#)



Aluminum Heatsink with bigger Fan for Jetson Xavier NX Module with Long Cable

SKU [114992746](#)



Aluminum Heatsink with Fan for Jetson TX2 NX Module

SKU [114992731](#)



Aluminum Heatsink with Fan for Jetson Orin NX/Xavier NX Module

SKU [110991904](#)

Accessory - Case

Product Name Case for NVIDIA Jetson modules

Introduction Case/enclosure can provide ultimate protection to your Jetson modules.
For those listed on the LEFT, they all have an internal cooling fan to ensure better heat dissipation when your Jetson modules are working on multiple demanding tasks.
For those listed on the RIGHT, they are compatible with all popular SBCs (including ODYSSEY - X86J4105, Raspberry Pi, BeagleBone and Jetson Nano/Xavier NX), and they are with a removable acrylic cover on the top and with a stackable structure to extend endless possibilities.

Case with Fan



Jetson Nano Metal Case/Enclosure - with Cooling Fan and Camera Holder

SKU [110991384](#)



Jetson Nano Metal Armour - Case with PWM Adjustment Fan

SKU [110061132](#)



Aluminum Case for NVIDIA Jetson Nano

SKU [114992052](#)

Case without Fan



re_computer case

SKU [114992152](#)



re_computer case silver version

SKU [110991405](#)



re_computer case(Silver Metal Edition)

SKU [110991484](#)

Customization services for NVIDIA Jetson Series

For Jetson hardware specifically, Seeed Studio offers customization services based on our existing carrier boards including J101, J202, and J401 services ranging from interfaces modification to certification.



In addition, we are open to hearing your new Jetson-based product development idea. If you can't find the off-the-shelf Jetson hardware solution for your needs, Seeed Studio's in-house R&D engineering team with over a decade of experience in SBCs and industrial computing can design for your specific application demands.

Check out our customization services at <https://www.seeedstudio.com/odm>, and submit a new product inquiry to us at produce@seeed.cc for evaluation.

J101

J101 is a cost-effective, high-performance, interface rich **NVIDIA Jetson Nano** compatible carrier board. It has nearly the same functional design and exact the same size as the carrier board of **NVIDIA® Jetson Nano™ 2GB DEVELOPER KIT**.



J202

J202 is a high-performance, interface rich **NVIDIA Jetson Nano / Xavier NX/ TX2 NX** compatible carrier board. It has the same functional design and size as the carrier board of **NVIDIA® Jetson Xavier™ NX DEVELOPER KIT**.

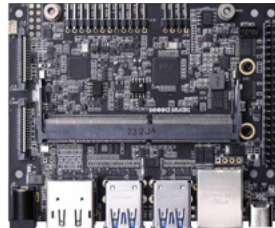

J401

J401 carrier board works with **NVIDIA Jetson Orin NX and Orin Nano**. It brings a rich set of I/Os to extend functionality: 2x CSI, 1x M.2 Key M, 1x M.2 Key E, 4x USB 3.2, 1x USB 2, HDMI, CAN, RTC and 40-pin GPIO.



EdgeAI Ecosystem

Transform Your Business Delivering Real-World AI Together

Integrate your unique AI technique into our current hardwares: Build your next-gen AI product powered by the NVIDIA Jetson module and bring your product concept to the market with Seeed Studio's **Agile Manufacturing 0-∞**.



Work with Amazing Ecosystem

Seed Studio is an Elite Partner of NVIDIA Partner Network(NPN), by consolidating our best-in-class hardware, over 14 years' expertise, NVIDIA's advanced system, cutting-edge technology from our software partners and the community, we aim at emerging all kinds of AI scenarios in our open-source platform to accelerate industry digital transformation.

We are calling for more ISV and solutions Integrator partners to deliver real-world edge AI solutions together.

- Integrating your unique technology, delivering to global embedded AI developers and enterprises.
- Building next AI products powered by the NVIDIA Jetson module, one-stop bringing your product to the market with Seed's manufacturing, fulfillment, and distribution.
- Working with Seed Studio amazing Ecosystem Partners together, unlocking more AI possibilities.

We are working with:

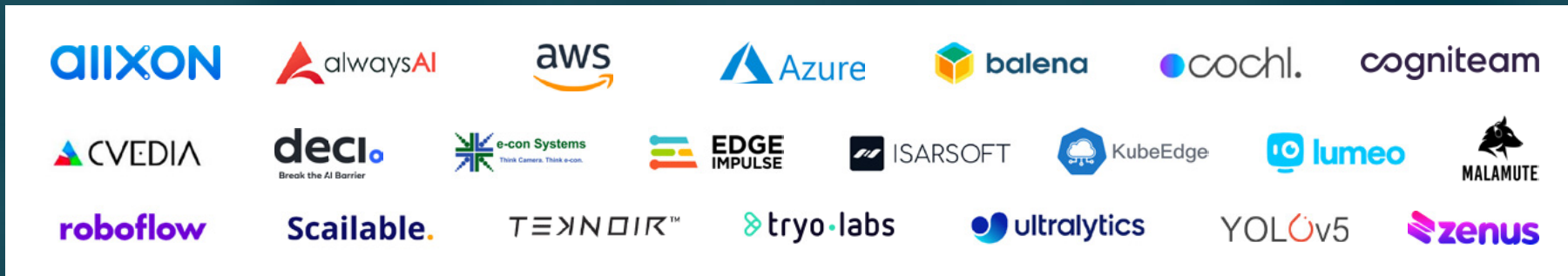

Buy seed Jetson products from NVIDIA partner and distributors



Edge AI Partner Program

Seed Edge AI Partner Program is free to [apply anytime](#). We are aiming at becoming the most reliable hardware platform and empowering everyone to achieve their digital transformation goals. Seed's Edge AI platform provides devices, carrier boards, peripherals, software tools and ML solutions. If you are working on AI products based on NVIDIA Jetson Platform, including Jetson Nano/ Xavier NX/ Orin NX/ Orin Nano. AGX Xavier/ AGX Orin, we are looking for global AI partners to join us as:

- Enterprise AI software partner
- AI solution integrator
- Community co-inventor

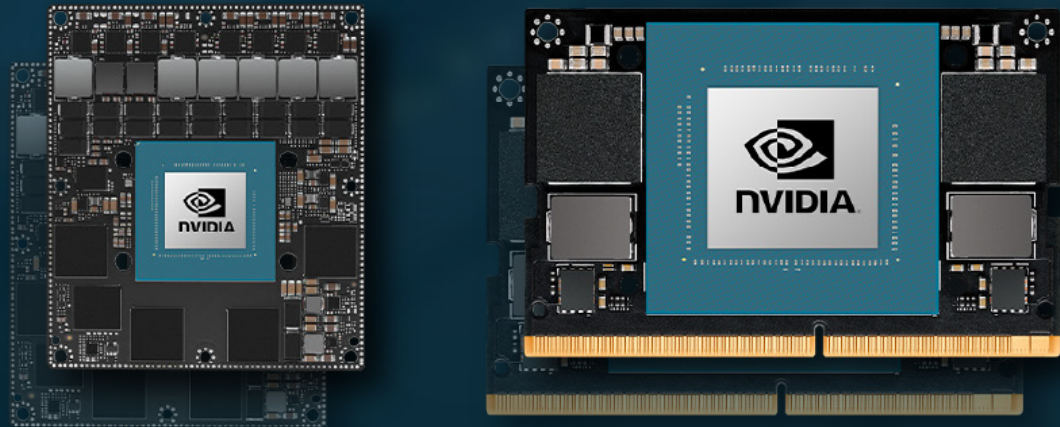

seeed studio

EDGE IMPULSE

Edge Impulse

Edge Impulse is the leading development platform for machine learning on edge devices, free for developers and trusted by enterprises. Edge Impulse made ML development easier, accelerate ML solution development using low-code to advanced integrations with the support from an expert.

Find our partner >> edgeimpulse.com

Application

Embedded Machine Learning
Computer Vision

Industry

Industry 4.0, Manufacturing, Retail

Industry

All Seeed's NVIDIA compatible carrier boards and devices, Official NVIDIA dev kit

Build ML pipeline for deploying audio, image classification, and object detection applications at the edge

Users of Edge Impulse can leverage the power of the Jetson Nano for their embedded machine learning applications that demand higher performance, alongside the industry's leading embedded ML platform that offers:

- The easiest-to-use embedded machine learning pipeline for deploying audio, image classification, and object detection applications at the edge with zero dependencies on the cloud
- Streamlined acquisition of critical environmental sensor data, previously discarded or only sent to the cloud, for empowering sensor fusion at the edge.

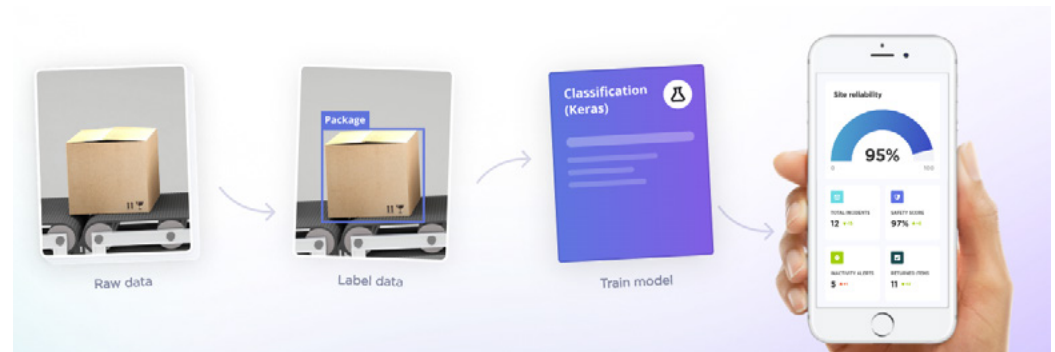

Deploy hard hat detection for enforcing workplace safety

Use Edge Impulse for end to end machine learning workflow: upload dataset, acquire custom data, visualize the data, train the machine learning model and validate the inference results. With Edge Impulse, you can easily deploy an automated real-time detection for hardhat-wearing compliance, along with the alert at the workspace. PPE compliance also includes gloves, masks, goggles, etc.

You can also build custom model training for the full PPE detection pipeline.

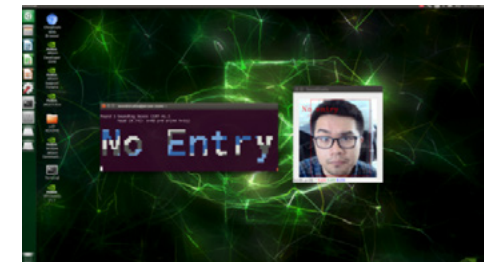

seeed studio

deci.
Break the AI Barrier

Deci

Deci empowers deep learning developers to accelerate inference on edge or cloud, reach production faster, and maximize hardware potential. Led by a team of world-class deep learning experts, Deci lets AI developers focus on what they do best - creating innovative AI-based solutions for our world's most complex problems.

Find our partner >> deci.ai

Application

Deep Learning, Model Optimization

Supported Hardware

All Seeed's NVIDIA compatible carrier boards and devices, Official NVIDIA dev kit

Getting Started with Deci on NVIDIA® Jetson Devices

“Our collaboration with Seeed will empower countless users with optimized deep learning models ready for instant deployment,” said Yonatan Geifman, CEO and co-founder of Deci, “No matter the hardware, nor if deploying on the edge or cloud, developers should have full accessibility to the latest developments in deep learning; this partnership brings us one step closer to that goal.”

Deci's platform includes several modules, one being a cloud-based runtime optimization engine which enables users to automate the manual model compilation and quantization processes (OpenVino and TensorRT) on a wide variety of hardware types with just a few clicks. The result is an optimized model for the user's inference hardware. Users can also use the platform to optimize models for edge devices, a process that typically can only be carried out after users have purchased the devices themselves.

The platform is powered by Deci's Automated Neural Architecture Construction (AutoNAC) technology, an algorithmic optimization engine that squeezes maximum utilization out of any hardware. The AutoNAC engine contains a Neural Architecture Search (NAS) component that redesigns a given trained model's architecture to optimally improve its inference performance (throughput, latency, memory, etc.) for specific target hardware while preserving its baseline accuracy.



seed studio

allxon

Allxon

Allxon is the market's first to provide powerful remote edge AI device management and disaster recovery solutions with Out-Of-Band (OOB) technology. As a partner of NVIDIA Jetson Ecosystem, Allxon delivers highly compatible solutions onto any branded Jetson platform.

Find our partner >> allxon.com

Application

OTA
Device Management

Device Support

All Seeed's NVIDIA compatible carrier boards and devices, Official NVIDIA dev kit

Efficient Remote AI system based on NVIDIA Jetson Platform

Edge AI Transforming Agricultural Landscapes

Farmers installed AI-driven cameras all around the farmstead to record, detect, and monitor livestock health and their lifecycle in real-time. These cameras are connected to and powered by edge devices, enabling the farmer to make informed data-driven decisions, be alerted to, and stay ahead of crisis situations, ultimately leading to the improvement of cattle management and economic growth.

Allxon Out-Of-Band (OOB) technology provides rapid disaster preventive measures. Seeed's Jetson powered edge devices that enable data-driven smart farming are highly safeguarded in an electrical enclosure, forming the nucleus where "ALL" data is perpetually collected and processed 24/7, 365 days a year.

It is imperative that the systems work seamlessly and uninterrupted for a highfunctioning farmstead.



seed studio

YOLOv5 

YOLOv5

YOLOv5 is a family of compound-scaled object detection models trained on the COCO dataset, and includes simple functionality for Test Time Augmentation (TTA), model ensembling, hyperparameter evolution, and export to ONNX, CoreML and TFLite.

Find our partner >> ultralytics.com

Application

Object Detection

Device Support

All Seed's NVIDIA compatible carrier boards and devices, Official NVIDIA dev kit

Facing The Gap between AI's PoC to Production: Fewer Datasets, Faster Training

Machine learning is quite widely adopted in software industry applications like social media, YouTube, and E-commerce. It is not tough to acquire a billion level data through the internet experience. However, looking into real-world applications, there are many other industries that only have access to small data, for example, medical imaging, manufacturing, and environmental research .

Use transfer learning along with Ultralytics YOLOv5 and Roboflow to train a dataset with very few samples. We first initialize a model with weights from a pre-trained model and then start training the machine learning model that we need using a dataset as small as 200 images.

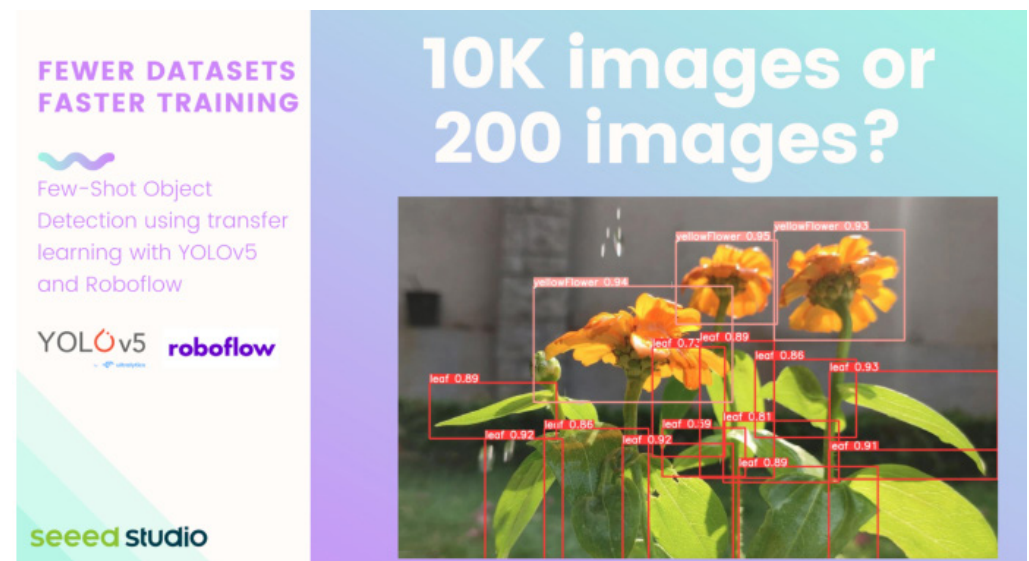

The image is a composite of two parts. On the left is a white poster with purple and green accents. The text on the poster reads: "FEWER DATASETS FASTER TRAINING" in purple, followed by a wavy line icon, "Few-Shot Object Detection using transfer learning with YOLOv5 and Roboflow" in purple, the "YOLOv5" and "roboflow" logos, and the "seed studio" logo at the bottom. On the right is a blue-to-green gradient slide with the text "10K images or 200 images?" in white. Below the text is a photograph of a yellow flower with red bounding boxes and labels: "yellowflower: 0.94", "yellowflower: 0.93", "yellowflower: 0.93", "leaf: 0.72", "leaf: 0.89", "leaf: 0.86", "leaf: 0.93", "leaf: 0.89", "leaf: 0.92", "leaf: 0.86", "leaf: 0.89", "leaf: 0.81", "leaf: 0.91", "leaf: 0.89".

seeed studio

cogniteam

Cogniteam

Cogniteam is a technology start-up, it brings standout software solutions for autonomous robots. Nimbus by Cogniteam is cloud-based ecosystem for robot fleet configuration, testing, deployment, and operations management. Nimbus makes your ROS journey intuitive using drag and drop tools and a rich set of ready-made AI algorithms that are ROS1/2 compatible.

Find our partner >> cogniteam.com

Application

Robotics Development

Device Support

All Seeed's NVIDIA compatible carrier boards and devices, Official NVIDIA dev kit

Seeed Partner with Cogniteam to Bring the Drag and Drop Robotics Development and Deployable Solutions for NVIDIA Jetson Platform

Robotics is a field of integrations, not merely development. You need to choose the correct computing power; you need to choose the right sensors, not develop them. It comes down to software integrations. With Nimbus, Cogniteam's cloud-based solution for robot developers and operations, all the above becomes simpler.

We are glad to partner with Cogniteam, aiming at delivering the easiest ever robot development process, from prototyping to production, including configuration, testing, deployment, and operations management.

Nimbus supports Seeed made Jetson powered platform carrier boards and min PCs, attach sensors such as RPLidar and cameras to build your robotic application from scratch.

You can also seamlessly connect your existing ROS projects to Nimbus. Based on the open-source Robot Operating System (ROS), Nimbus is truly a 'plug and play' solution.

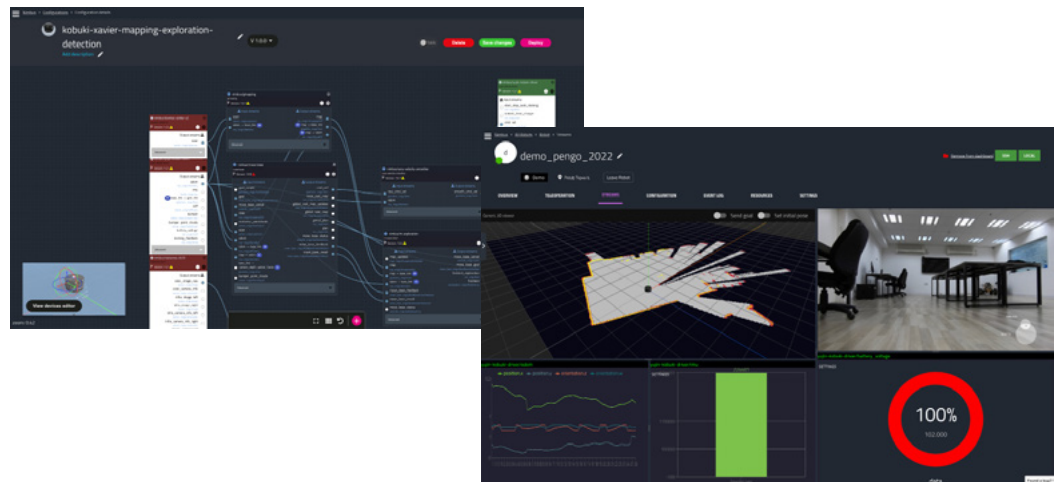

seed studio



alwaysAI

alwaysAI is a leading computer vision development platform that provides innovative enterprises real-time data to see into their operations with more depth and clarity than ever before. alwaysAI's enterprise grade computer vision models and applications are best in class, scalable and built to run on the edge or the cloud.

Find our partner >> alwaysai.co

Industry

Retail, Construction, Manufacturing

Application

Computer Vision

Device Support

All Seeed's NVIDIA compatible carrier boards and devices, Official NVIDIA dev kit

Seeed and alwaysAI Partner to Accelerate Deploying Computer Vision at The Edge

Seeed and alwaysAI began their cooperation with NVIDIA® Jetson™ powered devices. The partnership makes computer vision come alive on the edge - where work and life happen:

Retail

Using data from existing cameras (such as IP or surveillance cameras) retailers are leveraging alwaysAI to get immediate data about back end operations to improve efficiencies and drive more revenue. Retailers are also using alwaysAI to count customers in real-time, track where they go, which products they walk-by and engage with, and monitor wait times at checkouts.

Construction

alwaysAI is deploying applications in construction to help assess real-time progress of construction projects as well as track safety through personal protective equipment monitoring such as hardhats, safety glasses, and reflective vests. General contractors can get real-time visual data to improve operating margins, reduce liability, and manage direct labor and material costs more efficiently.

Transportation

Computer vision in manufacturing provides comprehensive oversight of manufacturing processes to enhance productivity and safety across the entire value-chain, from materials tracking to production and delivery. Computer vision enables manufacturers to automate processes with real-time data tailored to meet their specific needs.



seed studio

tryo·labs

Tryolabs

Expert team of engineers and advisors focused on making an impact with AI-powered solutions.

Machine Learning consulting services: Predictive Analytics, Computer Vision, and Natural Language Processing.

Find our partner >> tryolabs.com

Software

YOLOV5, DeepStream SDK, NVIDIA Metropolis

Industry

Industry 4.0

Application

Machine Learning

Device Support

reComputer J2011/J2022 Powered by NVIDIA Jetson Xavier NX

Detecting Safety Helmets in Realtime

Personal Protective Equipment (PPE) has made its way into mandatory requirements of construction sites due to its importance to workers' safety.

Tryolabs leverages Seeed's reComputer edge devices built with Jetson Xavier NX 8GB module to develop a computer vision analytics solution that tackles a challenging task in today's industry 4.0 - detecting safety helmets in real-time.

YOLOv5 vastly outperformed Faster R-CNN, obtaining better metrics in a much shorter time. In terms of inference time, both models performed similarly, taking around 0.08 seconds for each image on the edge device (12.5 FPS).

By leveraging DeepStream SDK, the inference time was boosted to a staggering 0.012 seconds for each image (82.8FPS) on the same NVIDIA Jetson Xavier NX.



seed studio

roboflow

roboflow

Roboflow empowers developers to build their own computer vision applications, no matter their skillset or experience. You can host a trained model with a single click or build your own custom models. Roboflow Annotate detects objects in your images and places bounding boxes around them. If an annotation is misaligned, it's easy to adjust its size and position.

Find our partner >> roboflow.com

Industry

Retail; Traffic Management; Manufacturing

Application

Computer Vision

Device Support

All Seed's NVIDIA compatible carrier boards and devices, Official NVIDIA dev kit

Train a Working Computer Vision Model with Fewer Images

We work with Roboflow to annotate images, directly import images or videos.

Roboflow help distribute the dataset into "training, validation, and testing", as well as add further processing to these images after labeling them. Furthermore, it can easily export the labeled dataset into YOLOV5 PyTorch format which is what we exactly need for fewer dataset needed!



You can download a number of publically available datasets such as the **COCO dataset**, **Pascal VOC dataset** and much more. Roboflow Universe is a recommended platform which provides a wide-range of datasets and it has **90,000+ datasets with 66+ million images** available for building computer vision models.

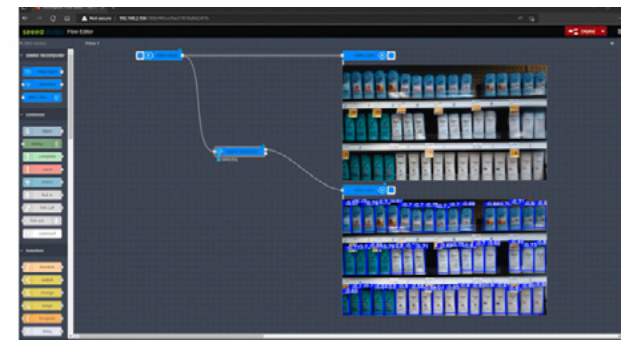

seed studio



Lumeo

Lumeo is an open and flexible video analytics platform which bridges the latest AI models and techniques with a growing audience attempting to bring intelligence and automation to market. They let customers harness AI with their existing cameras and infrastructure to make sense of video data for alarm monitoring, customer experience, marketing, compliance, physical security, and many more use cases.

Find our partner >> [Lumeo](#)

Industry

Industry 4.0

Application

Video Analytics AI Gateway

Device Support

All Seeed's NVIDIA compatible carrier boards and devices, Official NVIDIA dev kit

Bring No-code Video Analytics Platform to the Market through Vision AI

Seeed and Lumeo collaborate their partnership to deliver ready-to-use video analytics solutions at the edge to customers. Simply plug in the reComputer Industrial Edge device and set up the Lumeo engine browser-based configuration which is pre-installed in the device. The whole pipeline of deploying advanced video analytics has never been easier.

Together with Lumeo, from training, no/low code platform, and scale deployment, we speeds time to market for customers and bridges the gap between developers and real-world AI deployment. There are several ready-to-go applications you can deploy directly in the field. In retail space, you can count the number of people/vehicle.other objects, gauge dwell time by tracking the customers currently being served in queues, and calculate conversion rates for each sites. For transportation scenario, you can track the traffic flow, capture vehicle's detailed information, and identify the illegal driving behaviors. While specifically in the parking lot, you can detect the vehicle, count numbers coming in and out, detect license plates, and identify the parking spaces' occupancy with parking duration accumulation.



seed studio



Cochl

Cochl is a technology company based in Silicon Valley, USA and Seoul, Korea, developing products to apply machine listening technology to various industries. Besides applying computer vision technology in facial recognition and object recognition, it can also be deployed for acoustic recognition, allowing the computer to hear through speakers and analyze the events in real-time based on the sounds. For example, after identifying the sound of a gun or glass breaking, we help resolve the issue.

Find our partner >> Cochl.ai

Industry

Security

Application

Machine listening

Device Support

All Seeed's NVIDIA compatible carrier boards and devices, Official NVIDIA dev kit

Machine Listening on the Edge, Delivering Valuable Information from Sound for Safety

Machine listening covers a wider range and recognizes all sounds in the world, allowing you to extract various insights and information from audio data, and apply them to multiple industries, such as smart city, manufacturing, defense business, and smart home, in order to make effective decisions.

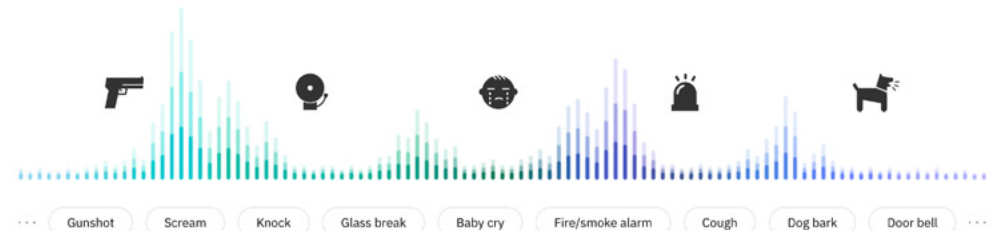

That's where we get started with Cochl to bring the sound event detection and speaker identification applications to our customers. With Cochl's 100+ sound model types, you can simply install the machine listening tech on the reComputer edge device with Cochl SDK, and also check the analysis results through the dashboard whether on mobile APP or web-based, achieving around 93% accuracy performance while deploying in the real-world environment.

To distinguish different speakers for recognition and detect anomaly situation, you may choose Jetson AGX Xavier or higher module for better performance. The whole system keeps your privacy and stability at the first as always. The sound recognition can be covered in wide range up to several hundreds meters away. Moreover, microphone doesn't need to send audio data continuously to the cloud as long as it's running at the edge, keeping people's psychological resistance to them as relatively low.

seed studio



CVEDIA

CVEDIA accelerates the development of autonomous applications. Pushing the boundaries of computer vision, they are committed to solving the clients' most challenging issues with simulation and sensor modelling, big data management, system integration, and neural network training. With the great support of CVEDIA-RT software stack, customers can easily configure and customize the video analytics solutions based on the dozens of pre-installed computer vision applications.

Find our partner >> cvedia.com

Industry

Smart City

Application

Video Analytics in Public Space

Device Support

All Seeed's NVIDIA compatible carrier boards and devices, Official NVIDIA dev kit

Deploying Ready-to-Use Video Analytics Solutions for Object Detection and Classification in Public Space

Seeed Studio collaborates with CVEDIA on intelligent security solutions running on Seeed's Jetson-based edge AI devices with ready-to-use models for perimeter security, intrusion detection, crowd control, vehicle and people counting, vehicle and people classification, tripwire, zone analytics, etc.



All features are delivered to detect active changes among people crowds or huge traffic flows, in order to identify the potential issues or risks. The system utilizes high-resolution cameras and sensors to provide precise counts of individuals, groups, and vehicles, store data for analysis and comparison, allowing for identification of trends and patterns over time. It's flexible to use since the CVEDIA-RT platform supports various input and output data formats, and even low-code scripting capability to seamlessly debug your own AI model.

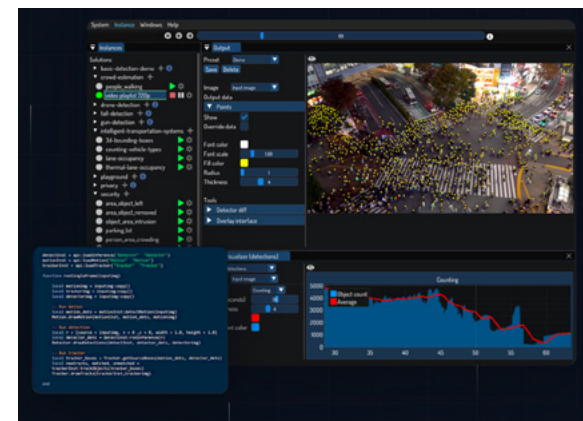

seeed studio

Scailable.

Scailable

Scailable is a leader in edge AI middleware, providing software tools for the efficient deployment of AI models on a variety of supported edge devices. With Scailable, companies can significantly reduce time-to-market, iterate faster, and enhance their AI capabilities.

Find our partner >> scailable.net

Application

Scale Deployment

Device Support

All Seeed's NVIDIA compatible carrier boards and devices, Official NVIDIA dev kit

Deploy AI Models at Scale with Jetson Edge Devices

Seeed collaborates with Scailable to offer a streamlined approach to deploy AI models on Seeed's Edge devices, like reComputer powered by NVIDIA Jetson Orin. It ensures developers efficiently utilize the hardware of GPU for rapid video decoding and efficient model inference, making the transition from Edge AI/ML Proof-of-Concept to actual large-scale deployment effortless.

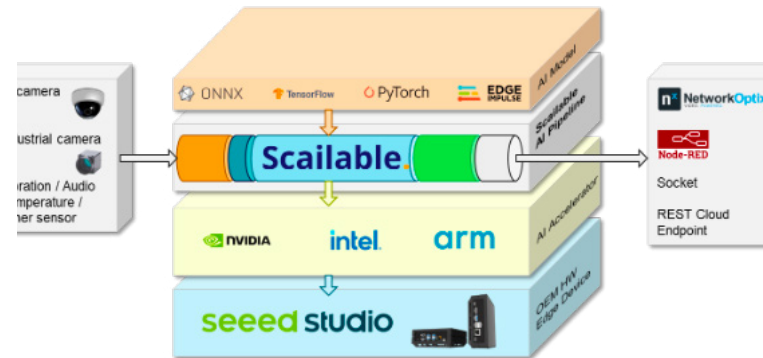

Scailable's middleware provides a platform-independent solution for deploying AI models on chosen edge devices, reducing time-to-market and enabling rapid iterations. Scailable's middleware has been developed to be modular from the ground up, fully portable across devices, and provides native performance. It offers a seamless AI deployment platform for scaling models to groups of edge devices via Over-The-Air (OTA) tools, delivering visualized detection results and the ability to send meta-data (inferences) to a variety of platforms. Check out our [wiki](#) to get started.

The screenshot shows a dashboard with two main sections: 'Custom Models' and 'Devices'. 'Custom Models' displays a count of 231 and a grid of blue squares representing individual models. Below it, there are links: 'View available models' and 'Add a new model by uploading an .onnx file.'. 'Devices' displays a count of 92 and a grid of blue squares representing individual devices. Below it, there is a link: 'Manage the registered devices'.



Malamute

Malamute's mission is to enable efficient communication in the toughest environments. Founded in 2020, the Malamute team sought to combine the industrial communication world with the power of AI, creating the next generation of communication workflow. Malamute has partnered with multiple industry leaders to bring human-centric assisted reality to the front lines.

Find our partner >> malamute.us

Industry

Industry 4.0

Application

Industrial Communications

Edge Device Used

NVIDIA Jetson AGX Orin Dev Kit, reServer J5014

Software

NVIDIA RIVA SDK

NLP Simplifies Industrial Communications and Improves Manufacturing Productivity

Challenge

In the industrial manufacturing workplace, workers are constantly having to leave their stations to communicate information. Having to manually locate individuals throughout the facility or use a tedious data input solution prevents workers from completing their jobs. Is there any way we can optimize the workflow of asynchronous communications to benefit both the worker and the workplace?

Solution

Malamute uses natural language processing(NLP) and spatial computing to help improve workplace productivity and process traceability. Powered by NVIDIA Jetson Orin and AGX Xavier module, and working with NVIDIA Riva, Malamute's AI-layered audio communication network empowers industrial workers with the right data at the right time. The NLP-powered communication system helps improve overall equipment efficiency by keeping workers focused on their jobs and at their stations. Employees can record voice messages regarding operational situations and processes which get sent to the intended audience. This allows for effortless and efficient communications compared to a Walkie-Talkie, phone call, or email.

Result

Minimizes worker travel for communications. Maximizes worker productivity. Improve workplace efficiency.

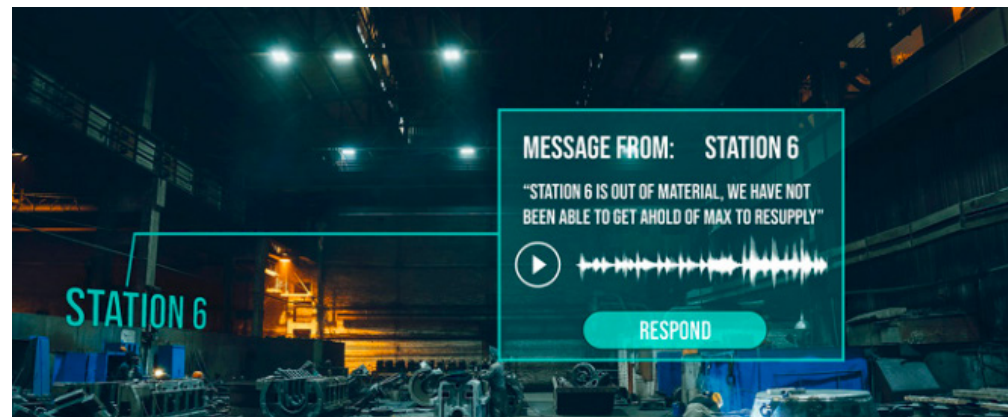

seeed studio

TEKNOIR™

Teknoir

Teknoir was founded in 2019 to reshape the industry's future democratizing artificial intelligence with its MLOps platform not only for data scientists but also for those that aren't data scientists or programmers via an intuitive, no-code dev environment in a hybrid cloud approach that enables inferencing of AI data on lightweight embedded devices at the far edge to drastically improve performance, security, and scalability.

Find our partner >> teknoir.ai

Application

MLOPs Platform
Computer Vision

Device Support

reTerminal powered by Raspberry Pi CM4
reComputer J2011, J2012, J2021

MLOPs Enables Easy Sustainable Recycling at the Edge

"Seeed continues to serve as an instrumental resource for Teknoir with their offering of innovative edge AI hardware solutions. Seeed's devices provide Teknoir with unique opportunities to develop AI solutions for its customers that address a variety of important use cases at the edge." -- Jonathan Klein, Founder & CEO at Teknoir.

Teknoir, offering MLOps platform and AI solution company, has been working with Seeed's reComputer J2011 and reTerminal, with their no-code Dev Studio for industry 4.0 applications such as workers' safety, manufacturing of workforce optimization, and preventative maintenance and smart city of recycling materials detection. Coupled with cameras, LTE and running Teknoir's Orchestration Engine, these edge devices have secure connectivity to the Teknoir Cloud. Teknoir's client-partner is able to use the Dev Studio for pushing their trained machine learning model, as well as managing the fleet of hardware and software.

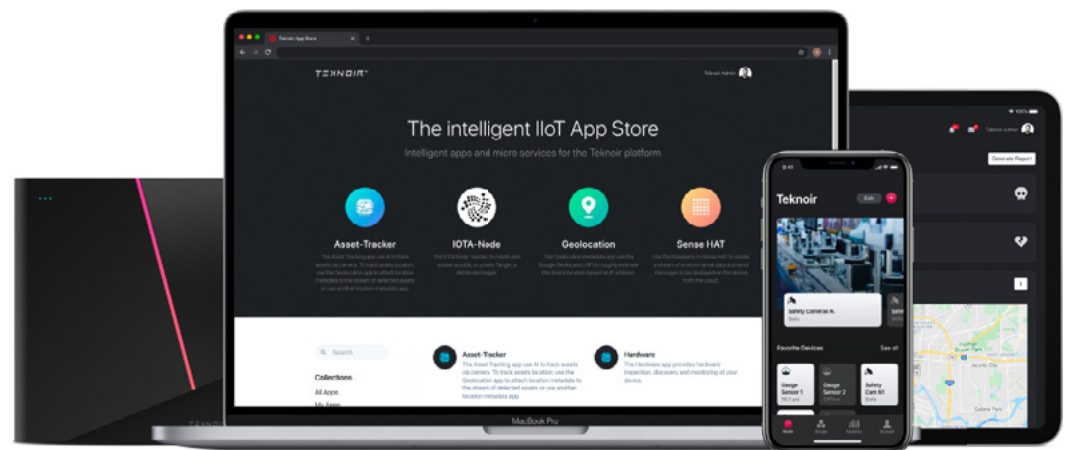



Prassel

Deployed in: Italy

Prassel is an Italian company with decades of experience in developing software solutions for security and safety. They design video analytics solutions, transfer expertise, and support partners and customers, ensuring cost containment and security investment enhancement.

Find whole solution >> [Prassel](#)

Industry

Automotive/ Warehouse

Application

Loss Prevention & Security Management

Edge Device Used

reComputer J2021, powered by NVIDIA Jetson Xavier NX

Software Support

Prassel's proprietary software interface

Use Case

AI-Driven Video Analytics for Automotive Dealer Warehouse

Challenge

Deploying an intruder detection system across multiple geographically dispersed sites usually meets these challenges for large organizations: customers want to avoid additional installations to minimize changes to the pre-existing security network, the existing camera system should also be utilized for intrusion detection both in the external perimeter and internal areas across 20 sites, and it's quite important to ensure that the system only triggers analysis of intrusion events caused by people, excluding false alarms caused by wild animals, particularly at night.

Solution

Magicbox integrates reComputer J2021 powered by NVIDIA Jetson Xavier NX module, Prassel's proprietary software, object detection, line crossing, privacy mask, smoke and fire detection algorithms. It also speeds up emergency responses and provides valuable business insights by recognizing specific conditions using email notifications with a snapshot or output over Modbus protocol to connected devices such as sirens, intrusion control units, and alarm systems.

Result

- 90% reduction in intrusion attempts
- Timely alerts to prevent tampering and intrusion attempts
- Easier to identify critical areas for video analytics across 20 sites



seed studio



BAUTA

Deployed in: Germany, Austria, Switzerland

BAUTA is a young German startup, funded by the German Federal Ministry of Economics and the state of Baden-Württemberg. With its Privacy-by-Design Concept, it technically solves the conflict of interest between “innovation vs. data protection” and enables computer vision access to the European Union. Bauta dedicates to promoting effective solutions which give innovation a unique data platform to support young start-ups and companies with sustainably successful smart city concepts, and also help strengthen the local economy by analyzing regular visitor data.

Find whole solution >> [Bauta](#)

Industry

Smart City

Application

Visitor Analysis & Pedestrian Count in Privacy

Edge Device Used

reComputer J2021, powered by NVIDIA Jetson Xavier NX

Use Case

Sustainable Data for Business Environment Perception in Smart City

Challenge

The potential for unlimited data capture and analysis by smart cameras is undeniable, but the privacy implications of such technology cannot be ignored. Moreover, retail, out-of-home advertisers, and public city departments need to get intelligent insights by analyzing visitor frequency and customer behavior data to help improve local economic growth.

Solution

BAUTA's blind sensors offer a compromise between data potential and privacy by recording anonymous information that can be analyzed with specially trained neural networks. The system integrates the reComputer J2021 of NVIDIA Jetson Xavier NX module and BAUTA sensors to process and analyze data on gender, age distribution, visitor frequency, dwell time, moving direction, and traffic analysis/count & vehicle categories.

Result

Based on the sensor data, Out of home-marketers can accurately evaluate and price the reach of the advertising spaces (analogous to online advertising) transparently, helping to find the desired target customer group. All of the data is anonymous and are ethical considerations surrounding privacy to create a sustainable future.



Armitage

Deployed in: **China**

Established since 1972, **Armitage** is one of the leading IT services providers in HK and PRC. Over 150 IT professionals, they have 50 years experience and proven track records in delivering quality solutions to various sectors public /private sectors.

Find whole solution >> [Armitage](#)

Industry

Smart City

Application

Patrol Robot

Device Support

A206 carrier board compatible with NVIDIA Jetson Xavier NX
reComputer J2021, powered by NVIDIA Jetson Xavier NX

Software

DeepStream, PaddleOCR

Use Case

Robot Security Guard Patrols in Hong Kong Parking Lot

Challenge

Compared with security guards with human power, collaborative robots are more and more important to provide the highest level of public security in an effective way, dealing with continuous security tasks and adapting to blind ends that humans can't reach.

Solution

Armitage provides Patrol Robot solution bringing 24/7 peace of mind to Hong Kong's underground parking lot with fully automatic robotic security guards without operator supervision.

- License Plate Recognition System (LPRS)
- Operate 24/7 without human intercession
- Facial recognition, people counting
- Fire and smoke alarm

Benefits

- Reliable 24/7 security monitoring, day or night, in any weather
- Capable of identifying various types of objects/situations
- Real-time video and transmission
- Significant savings in manpower and filling the loophole after staff's patrol each time
- Reduced driving, walking, idling, and unnecessary effort in finding a space



seed studio

DOGU 도구공간

Dogugonggan

Deployed in: Japan

Dogugonggan was founded in March 2017 in Seoul, South Korea, mainly focusing on AI and autonomous robots in the security service industry. Currently has two robots, Iroi and Patrover, in its product line and was selected as a research lab for the Technology Creative Seed Project. They have 10 autonomous patrol robots used in different parts of South Korea with plans to scale up production in the next two years.

Find whole solution >> [Dogugonggan](#)

Industry

Robotics

Application

AMR Autonomous Mobile Robot
Outdoor and Indoor Security Robot

Edge Device Used

AGX H01 Dev Kit /reComputer J2021 /A205 carrier board

Software Support

TensorRT

Use Case

Robot Iroi and Patrover Integrated with 1:N Simultaneous Monitoring for Security

Challenge

Security patrols includes repetitive work in most of time, but the job can also bring risk of danger in the blink of an eye, such as a fire that can escalate and potentially injure people, especially security personnel. This is an area well suited for robots to perform repetitive tasks autonomously and still allow humans to interact remotely with the environment.

Solution

Dogugonggan develops both indoor/outdoor full stack autonomous robots: Iroi and Patrover are powered by different NVIDIA Jetson solution and integrate with computer vision AI, thermal AI, sound AI, gas detection, and video streaming. Dogugonggan provides a stable operation of security services by deploying self-driving robots equipped with patrol-specific AI and synchronous monitoring solutions (**1:N control**). Besides security, Iroi and Patrover will also help with air quality monitoring by integrating with CO2, NO2, SO2, VOC, PM2.5, PM10, temperature, and humidity multiple environmental sensors.





Smart Ocean Systems Laboratory

Deployed in: U.S.

The [SOS lab](#) is founded in October 2018 by the Principle Investigator, Mingxi Zhou. The lab is located at beautiful Narragansett Bay Campus, University of Rhode Island. The lab has various types of marine robotic platforms and a full suite of sensors for conducting research.

Find whole solution >> [SOS Lab](#)

Industry

Ocean Research

Application

Robotics, ROV

Edge Device Used

BlueROV2

Add-on sensors

Jetson Sub Blue mini PC, powered by NVIDIA

Jetson Xavier NX

Use Case

Towards Under-ice Sensing Using a Portable ROV

Challenge

Due to the lack of robust under-ice sensing techniques, the research of biogeochemical processes such as gas bubbles, basal ice melting, and drivers of sea ice algal blooms remains limited in the ice-covered area. It is also difficult to perform localization reult only based on the basic BlueROV model.

Solution

From 2020, SOS Laboratory from the University of Rhode Island is working on the project of Navigating Unmanned Underwater Vehicles (UUVs) at the Ice-water Boundary. The project team reported their progress in using a portable ROV for under-ice sensing, and demonstrate the feasibility of using small ROVs (0.7m long and 0.5m wide) to sample the under-ice environment near the coast.

- Capable of running on the flat landfast ice several hundreds meters off the coast stably
- Easy to show visual sensing and navigation results that can depict the ROV trajectory clearly

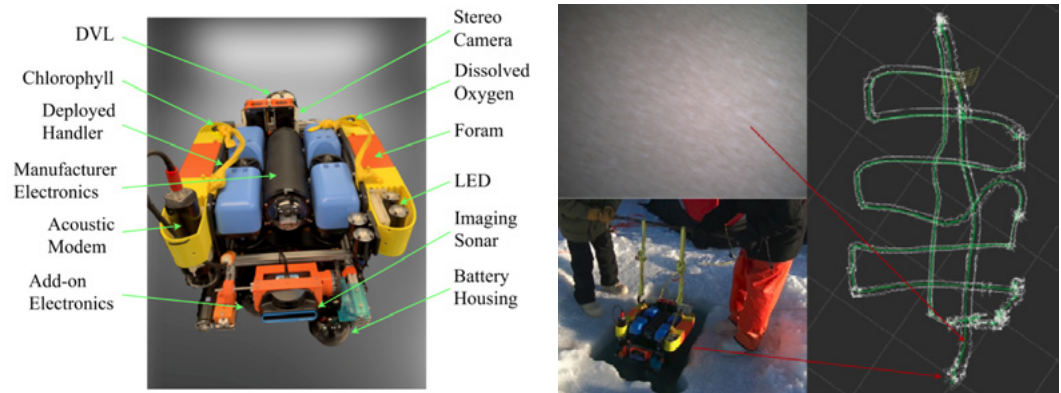

seed studio



KEISUUGIKEN

KEISUUGIKEN is a research and development location where advanced technology specialists from various countries gather together. They are working to expand products and services such as robots, artificial intelligence, and VR in collaboration with overseas companies and researchers.

Find whole solution >> [Keisuugiken](#)

Industry

Industry 4.0

Application

Warehouse Towing Robot

Edge Device Used

Jetson Sub Mini PC, powered by NVIDIA Jetson Xavier NX

Use Case

Meet PITAKURU, an Autonomous Towing Robot Capable of Towing Loads in the Warehouse

Challenge

Moving businesses online becomes new mainstream trends, making delivery services the new normal. In line with the growth of the online business, the demand for courier services that help deliver the ordered packages has risen significantly. Accordingly, the burden it has on the workers also increased.

Solution

In face of this new challenge, KEISUUGIKEN and Seeed came together to provide an autonomous towing robot called "PITAKURU". "PITAKURU" has the ability to track humans while towing heavy objects and can be operated indoors and outdoors. It uses laser tracking, enabling to follow individuals without being affected by external light, and there is no need to install accessories such as tracking beacons. These features enable "PITAKURU" to be used anywhere with easy access, even if the users are unfamiliar with the use of towing technologies.

Business Impact

By introducing "PITAKURU", the amount of cargo that can be handled by one worker will increase up to two to three times more, and the time needed to move packages around the warehouse, enhancing visibility of traffic.





Intflow

Deployed in: South Korea, Spain, Japan, Austria, Poland

Intflow is a deep-tech startup founded in 2019 with the goal of eliminating industrial inefficiencies by developing the world's best non-contact biometric information analysis technology.

Find whole solution >> [Intflow](#)

Industry

Agriculture

Application

Livestock Management

Edge Device Used

reComputer J1010, powered by NVIDIA Jetson Nano

Software Support

Intflow EdgeFarm, TensorRT

Use Case

Precise Livestock Management Helps Farmers Optimize Livestock Productivity

“With Seeed’s reComputer J1010, we can reduce the management cost per animal by 98% compared to the competing solution that relies on GPU-cloud because the Edge AI solution with Jetson could provide the lowest inference cost per a camera channel.” Kwang Myung Jeon, CEO at Intflow Inc.



Challenge

The livestock industry is huge, however, several issues impede its productivity, such as the soaring feed prices due to extreme weather conditions, disease risk, environmental and pollution regulations.

Solution

Intflow provides EdgeFarm, an AI solution that perceives livestock injuries and diseases to help farmers manage and optimize livestock productivity. EdgeFarm obtains the biometric data of each 40 piglets for each ceiling-mounted camera.

It measures real-time data of the pigs for example, its eating and exercising habits.

Business impact

The whole solution helps detect and track normal daily animal activities 24/7, recognize special behavior to alert fast, and increase gross revenue by 15% ~ 40% because of the increasing production. Typically 10 EdgeFarm systems can own 4000 animals in the farm. The cost might be around \$5,000 - \$10,000 based on the farm's location and condition.

seed studio



Zenus

Deployed in: **U.S.**

Zenus is an Austin, Texas, startup that offers a fully-integrated solution for safe data capture of consumer behavior. Zenus has packaged powerful AI models into a smart device powered by NVIDIA SoMs, to drive the ethical use of facial analysis for the in-store retail market. Their proprietary technology produces reports about consumer behavior and engagement without the risk of data theft or personal identification.

Find whole solution >> [Zenus](#)

Industry

Retail

Edge Device Used

A206 carrier board compatible with NVIDIA Jetson Nano/Xavier NX/TX2 NX

Use Case

Sentiment Analysis in the Retail Industry Becomes More Accessible

Challenge

Brands need to understand their customers on a deeper level. Passive solutions such as facial analysis sit on the cutting edge of AI and provide rich information. But they comprise many bits and pieces, making them hard to deploy in stores. In addition, brands operate under continuous changes in merchandise display, floor plan layout, audience demographics, and regional trends.

Solution

Zenus and Seeed came together to provide an all-in-one solution powered by NVIDIA Jetson to simplify the process and fulfill your needs. Picture a smart device that connects to any camera and processes the video feed locally. All you need to do is power up the unit and it instantly works. The device sends the meta-data to the cloud to generate actionable reports. You have access to real-time metrics such as impressions, demographics, positive sentiment levels, and more. All the information is ethically sourced and displayed on a live dashboard.

Result

- Improve conversion rates and increase sales by up to 382%
- Assess consumer satisfaction and demographics with over 95% accuracy





GOPIZZA

Deployed in: South Korea, India, Singapore

GOPIZZA is a global food tech company revolutionizing the pizza industry with cost-effective, one-person pizzas through ICT-based smart kitchens. With the special parbaking dough and patented automatic oven, they produce pizza quickly and evenly within minimum staffs.

Find whole solution >> [GOPIZZA](#)

Industry

Quick Service Restaurant (QSR)

Application

Food Production Line Automation
High-quality Food Production Control

Edge Device Used

NVIDIA Jetson Nano Developer Kit-B01
NVIDIA Jetson Orin Nano Developer Kit

Software Support

GOPIZZA cloud-based management platform GOVIS

Use Case

Automated Pizza Making System with Consistent High-Quality Food Processing and Intelligent

Challenge

The traditional QSR meets a significant hurdle of labor cost reduction and final product delivery standard maintaining. It is usually time-consuming to train employees with flavor combination and ingredient operation. Moreover, the food quality could be various under human check

Solution

GOPIZZA provides full automated system with three core functions:

- GOVIS - Store operation guidance and control cloud-based platform
- Ingredient combination station - Using object detection model to determine topping and flavor combination based on specific menu
- Gobot - a collaborative robot powered by visual data

It also shows food quality score during each grouped recipe step, in order to keep the same standard of the final food quality delivery

Business impact

Typically, one 5-6 m² quick service restaurant needs one GOPIZZA system, including:

- 1 automated topping selection table
- 2 ovens to monitor pizza baking progress
- 1 final product inspection station

Reduce human power from 3-5 employees to 1 for smooth restaurant operating management

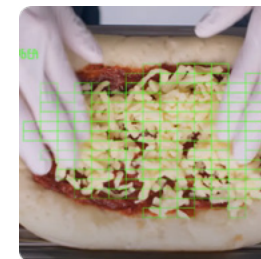

seed studio



Aivero

Deployed in: Norway

Aivero is a leading software company based in Norway and Denmark. It simplifies the use of 2D and 3D visual information in computer vision and AI applications, enabling high-performance applications that require precise depth perception, delivering its product as a SaaS or an on-premise hosted system that can be used in a variety of applications such as manufacturing, security, and robotics.

Find whole solution >> [Aivero](#)

Industry

Robotics & Logistics & Manufacturing

Application

Depth Video Data Capturing & Management
Environmental Perception

Edge Device Used

reServer J2032, powered by NVIDIA Jetson
Xavier NX

Software Support

Aivero management platform

Use Case

High Frame Rate Video Streaming Analytics with 2D&3D Depth Camera

Challenge

One key issue is the bandwidth bottleneck associated with 3D depth image compression. It is usually difficult to accurately capture real-world geometry because of the data rate with RGB-D video streams of ever-increasing resolution and frame rate, which means it could not handle abrupt depth discontinuities based on the traditional methods.

Solution

Aivero simplifies the steps of producing a colorful depth map and converting the 2D/3D visual data to a point cloud with various type of camera SDK/data formats. The cloud-based management platform is capable of:

- Camera setting management
- 2D/3D visual data compression, storage, and preview
- connections to ML training frameworks and AI inferencing tools

Business impact

The real-time, low latency streaming solution achieves high image quality level but less computationally expensive, supporting up to 3.072 meters when using a 1 mm/step resolution.

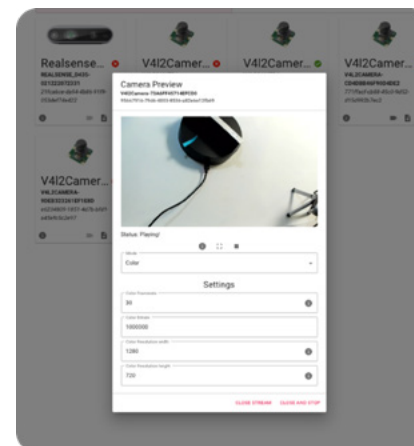



CuboRex

Deployed in: Japan

CuboRex is a global food tech company revolutionizing the pizza industry with cost-effective, one-person pizzas through ICT-based smart kitchens. With the special parbaking dough and patented automatic oven, they produce pizza quickly and evenly within minimum staffs.

Find whole solution >> [CuboRex](#)

Industry

Agriculture & Robotics Development

Application

Rough Terrain Robot

Edge Device Used

reComputer J4012, powered by NVIDIA Jetson Orin NX

Software Support

OpenCV, TensorFlow, Pytorch, NVIDIA TAO Toolkit

Use Case

Rough Terrain Robot for Farm & Construction Site Deployment

Challenge

Challenges occur while dealing with heavy lifting tasks in uneven terrain environments. Traditional human labor is expensive and time-consuming. People also get stucked at the beginning of robot automation development because of lacking hardware technology.

Solution

CuboRex delivers CuGo V3 crawlers as the out-of-box robot developer kit.

- Jetson-powered AI/CV processing with object detection, semantic segmentation, and PoseEstimation models
- Customize the NavigationStack-autonomous driving application that comes with ROS/ROS2
- Gather environmental information with a 2D LIDAR (RPLIDAR) and a GNSS (CLAS)

Business impact

The robot can handle heavy loads up to 70 kg even in a 20° slope hazardous environment, leading to increased output and potentially reducing labor costs.



seed studio



AUTILENT

Deployed in: Middle East

Atilent is a cutting-edge startup that aims to revolutionize the fleet management and driver monitoring industry. Based in KSA, Atilent offers customized hardware and software solutions to its clients and combines driver monitoring, ADAS, and fleet management into a single offering.

Find whole solution >> [Atilent](#)

Industry

Transportation & Fleet Management

Application

Abnormal Behavior Detection

Edge Device Used

reComputer J101 carrier board compatible with NVIDIA Jetson Nano

Software Support

Atilent management platform

Use Case

Smart Transportation for Driver Behavior Detection and Fleet Management

Challenge

Road transportation safety is always the top one issue we need to concern about. Accidents are usually caused by driver fatigue, drowsiness, and distractions. It is crucial to keep tracking drivers' status for safety and enhance the fleet management for more efficient business operations.

Solution

With deep learning algorithms combing with detection models such as face detection and object detection, Atilent successfully leads to faster and more accurate analysis of driving behavior, road conditions, and potential hazards .

The system will count all times that the authorized drivers' abnormal behavior is detected. You can easily check the report of driver/vehicle information, status, and their history data.

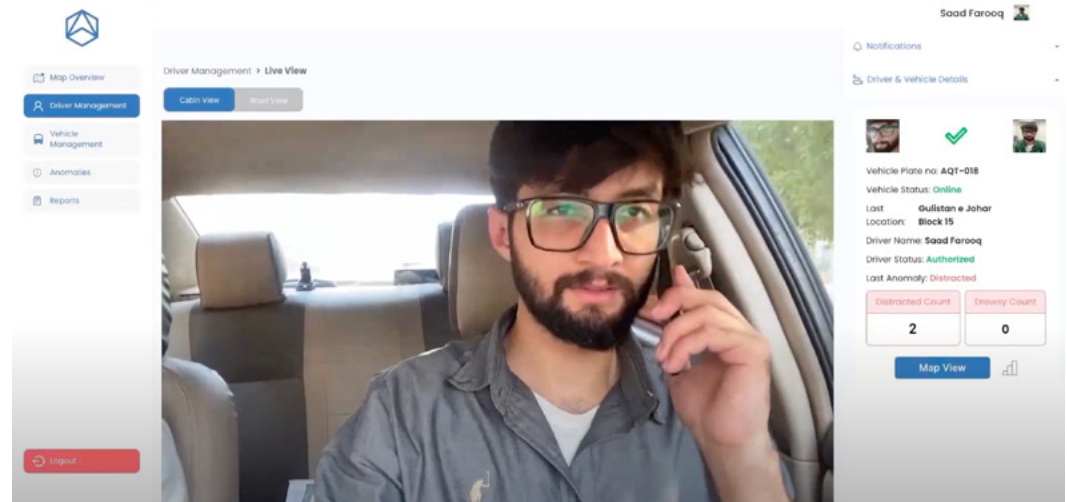

seed studio



Isarsoft

Deployed in: **Germany, U.S.**

Isarsoft specializes in the development of advanced video analytics solutions, renowned for their reliability, user-friendly interface, and extensive range of integrations. With Isarsoft, you can transform any camera into an intelligent sensor, capable of performing various tasks such as passenger counting, monitoring conversion rates, and measuring city traffic.

Find whole solution >> [Isarsoft](#)

Industry

Infrastructure Management
Smart Transportation

Application

Video Analytics

Edge Device Used

reComputer J4012, powered by NVIDIA Jetson Orin NX

Software Support

Isarsoft management platform

Use Case

AI-powered Video Analytics Solution for Airport Operation Management

“The combination of Isarsoft’s real time video analytics software Isarsoft Perception with the Seed Studio reComputer Edge AI Device opens the possibility to gain business intelligence from existing security cameras”

- Oskar Haller, CEO of Isarsoft

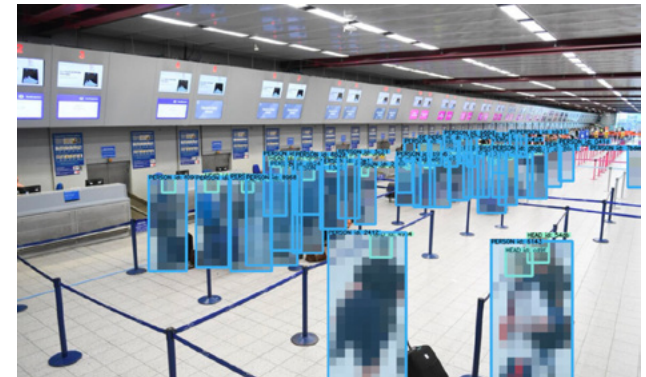

Challenge

For smooth travel, high safety, and optimal management, airport operating management always meets these challenges such as: monitoring enormous live video data continuously by human labor is time-consuming and expensive; in the meanwhile, it is crucial to prevent large crowds and chaotic situations for customer experience enhancing.

Solution

Infrastructure optimization:

- Create shorter routes for time saving
- Analyze occupancy statistic to optimize queue experience
- Baggage carousel analysis to avoid misplaced

Airport perimeter protection:

- Identify and detect object
- Measure volume and density
- Analyze airplane KPIs such as speed, trajectory, and dwell time

seed studio



Vive Robotics

Deployed in: **Global**

Vive Robotics is a robot-developing company that is diving into tennis sports and providing game-changing ball retrieving solutions to improve the tennis experience with autonomous robots.

Find whole solution >> [Vive Robotics](#)

Industry

Robotics (Outdoor Activity)

Application

Tennis Ball Retriever Robot

Edge Device Used

NVIDIA Jetson Nano Developer Kit-B01

Software Support

NVIDIA DeepStream Toolkit, TensorRT, ROS

Use Case

Edge AI-Enabled Ball Retriever Robot for Tennis Game

Challenge

One of the hundle could be finding a proper object detection algorithm to spot small tennis ball from distance, and also localizing the robot within the tennis court. In the meanwhile, it is important to make the robot portable and lightweight as a consumer product.

Solution

Vive Robotics delivers this tennis ball retriever robot solution to improve tennis game experience:

- Recognize tennis ball at the beginning, followed by the detection and tracking of players
- Robot kicks the ball back to the player

Business impact

- For players: Reduce 15%-20% chasing down ball time
- For club: Generate a monthly recurring revenue of up to \$300/court, operating at only 25% of capacity (60 hours/month)

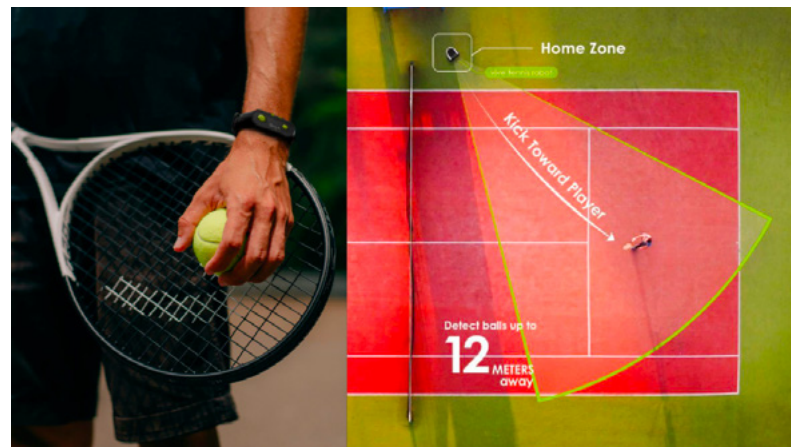



Lixo

Deployed in: **Global**

Lixo delivers cutting-edge, high-tech solutions to the waste management and recycling industry. By focusing on waste polarity and leveraging the principles of the circular economy, they strive to make a meaningful impact by effectively closing the loop and creating a sustainable future.

Find whole solution >> [Lixo](#)

Industry

Waste Management

Application

Waste Sorting & Collection

Edge Device Used

NVIDIA Jetson Xavier NX

Software Support

Lixo management platform

Use Case

AI-powered Waste Recycling for Traceability and Management

Challenge

Since waste resources might be highly deformed, jagged, and superimposed after collecting and processing through machine, the identification accuracy could be extremely difficult to maintain. The lighting conditions also influence the recognition capability. Meanwhile, waste recycling needs refined classification of pollutant components, in order to better understand waste quality and its recycling potential.

Solution

- Support more extensive waste materials classification (including PET - color and type of objects, HDPE, PP, LDPE, newspaper, magazine, print, greyboard, cardboard, dangerous or unwanted items, steel, aluminum, and green waste)
- Equipped with a camera near the garbage truck door, capturing three images per second once the dorr is lifted
- Check geographical analysis report for recycling performance and type of collection

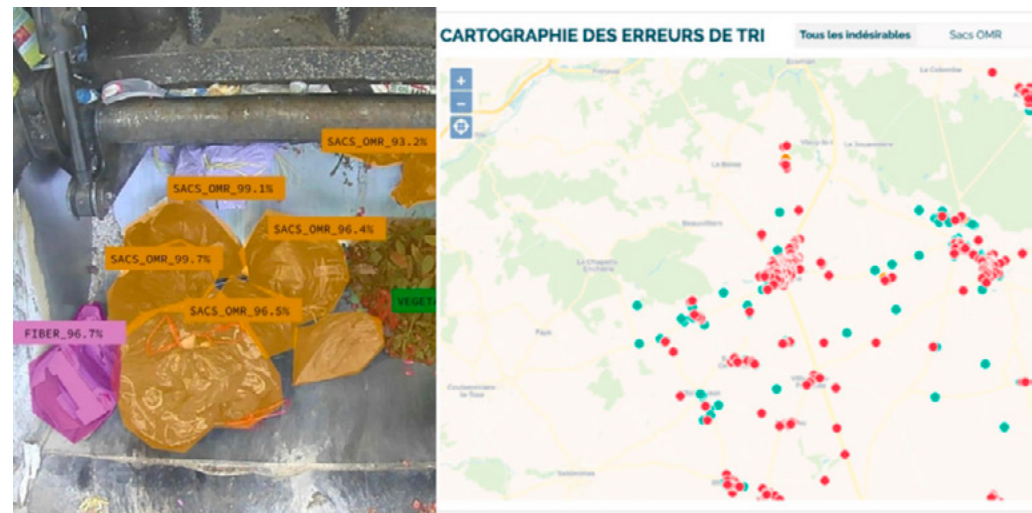



University of Waterloo

Deployed in: **Canada**

A research team led by Amir Khajepour, a professor of mechanical and mechatronics engineering in [UoW](#), has spent four years and well over \$1 million on the autonomous bus project, dubbed WATonoBus. It's aiming to do the research for making autonomous vehicles safe and reliable for urban driving in any weather condition, continuously testing and collecting data for optimizing this cross-disciplinary research to enable Level 4-5 automated driving.

Find whole solution >> [UoW Autonomous Shuttle](#)

Industry

Autonomous Driving & Transportation

Application

Environmental Perception & Path Planning

Edge Device Used

reComputer J4012, powered by NVIDIA Jetson Orin NX

Software Support

Allxon OOB & OTA Service

Use Case

Autonomous Shuttle Bus at University of Waterloo: AI-powered Driving Environmental and Traffic Perception

To address complex road challenges and enhance campus safety, aiding autonomous driving and predicting object trajectories in a bustling and uncontrolled area, the University of Waterloo initiated a research project deploying the autonomous shuttle bus WATonoBus.



Challenge

One challenge occurs on how to collect the interactive information effective and accurate, which comes from an array of sensors such as cameras, lidar, and radar. Besides, it's also crucial to deal with the precision to enable local mapping capability and enhance the estimation of pedestrian and vehicle intents on the road.

Solution

The Autonomous Bus integrates a sophisticated sensor suite, including three front-facing cameras with a 32-line Lidar, two side cameras, a rear-facing camera, and a 32-line dome Lidar for comprehensive local coverage via an Ethernet port. Two Radars on the front and rear, along with high-precision GPS, IMUs, and wheel encoders, ensure precise vehicle positioning. Allxon OOB technology facilitates remote system rebooting, and the OTA service enables seamless software and system configuration updates, ensuring continuous operation on the latest versions.

The reComputer Jetson Orin NX Edge device efficiently processes data from these sensors, accommodating two Baslet dart board-level cameras at up to 160 fps with 1080p resolution each via USB 3 ports (20 fps in the campus scenario). The system employs a decision module to estimate surrounding entities' intent from rich perception data, enabling effective path planning for safe navigation and obstacle avoidance in various situations.

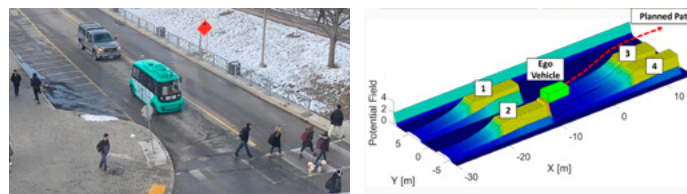

seed studio



Spectur

Deployed in: Australia, New Zealand

Spectur provides security, safety, environmental monitoring, and visual AI solutions that contribute to making communities safer, smarter, and more sustainable. They develop, manufacture, and sell solar-powered and remotely connected hardware, and also write firmware, software, cloud, and web apps that enable solutions to be delivered reliably and securely to customers.

Find whole solution >> [Spectur](#)

Industry

Smart City

Application

Security Management

Edge Device Used

reComputer J1020v2, powered by NVIDIA Jetson Nano

Use Case

Smart Security Sites for Community Safety Maintaining and Early Warning

Challenge

Transitioning from traditional monitoring systems to advanced technologies like autonomous monitoring systems with active deterrence is crucial in enhancing crime prevention. Unlike traditional systems that merely record incidents, autonomous monitoring systems proactively deter potential criminals and respond effectively to threats, preventing criminal activities. This shift is particularly urgent in regions experiencing increases in unlawful entries and property damage.

Solution

Spectur introduces the HD6 solar-powered site safety system, powered by NVIDIA Jetson Nano, featuring an integrated custom interface board with Modbus communications and watchdog functionality. This AI vision system, inclusive of an IP camera, LED floodlight, PA speaker, and 4G modem, offers 24-7 monitoring services in unwired environments. With a 45 to 110-degree field of view and passive infrared detection, the HD6 cameras provide continuous vigilance, covering 120-150m for effective detection. It easily distinguishes human and vehicle movement, filtering out over 95% of false alarms from animals, clouds, or other objects. Upon detecting a person or vehicle, the cameras promptly generate audible and visual alarms on-site and dispatch events to Spectur users, ensuring swift responses to potential security incidents.





TECHRAIL

Deployed in: Italy

TECHRAIL is an innovative company with more than two decades of experience in the innovation, design, and development of transport technology systems, Defense, telecommunications, and industry.

Find whole solution >> [TECHRAIL](#)

Industry

Smart Transportation

Application

People Distance Identification

People Counting

Edge Device Used

reComputer J202 carrier board compatible with NVIDIA Jetson Nano/Xavier NX/TX2 NX

Use Case

Utilizing 3D Scene Reconstruction for Individual Distance Identification on Subway

Challenge

The initial idea was born from the pandemic, when government around the world required social distance measures to manage crowds and mitigate the virus's impact. There is limitation for traditional method to assess people distance accurately in real-time.

Solution

Techrail introduces this innovative solution based on passive stereographic technology:

- Accomplish data processing and inferencing tasks for real-time 3D scene reconstruction
- Detect both people distance in 3D-mapping and the number of people in the subway carriage every 2 seconds, with object detection models
- Provide grids as visible result to show exact people position for distance calculation less than 1m

Business impact

- Typically, one 16m bus can be thoroughly covered by 3 Right Metro boxes
- The margin of identifying accuracy error can be tightly controlled within a mere 1%
- Control staff can manage information on each individual carriage and transfer it to information panels when the train arrives at each station

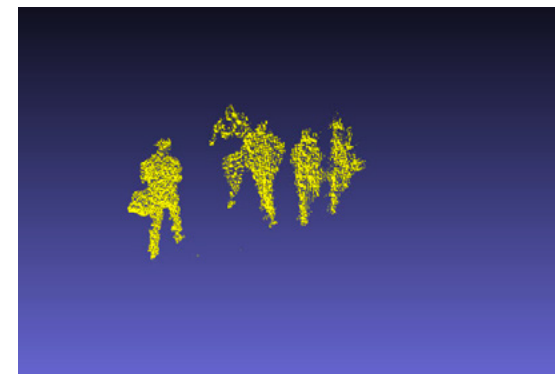
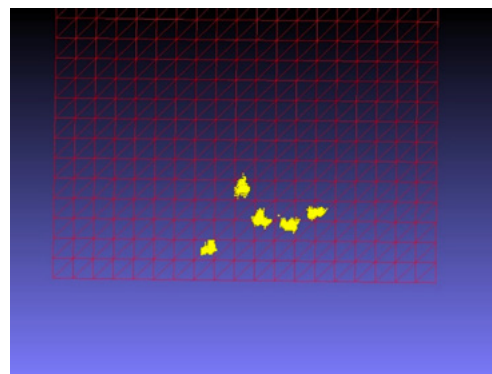

Azimorph

Founded in 2021, Azimorph is a group of passionate engineers based in Singapore who aim to make robotics' delivery the new normal.

Find whole solution >> [Azimorph](#)

Industry

Smart Logistics

Application

Delivery Robot

Edge Device Used

reComputer J2012, powered by NVIDIA Jetson Xavier NX

Use Case

Meet Techie: On-demand Autonomous Delivery Robot

Challenge

Many businesses have started to rectify their last-mile delivery operations. Their current operational process is to hire third-party courier companies, and it is very inefficient as it requires an astonishing amount of effort and time. Furthermore, as e-commerce continues to thrive, it will cause an upsurge in parcel deliveries and other issues, especially in densely populated cities.

Solution

Techie is a smart navigation delivery robot built by Azimorph, seeking to eliminate the need for door-to-door deliveries. The robot would navigate its way toward the consumer's house according to the time selected by the consumer beforehand. After which, Techie will return to the centralized bay to charge or load up more parcels. Techie comes with a safety feature that stops it when danger or unforeseen circumstances are detected, for example, a human in its path, construction zones, or roadblocks.

Result

- Reduced manpower cost, no need for last mile delivery drivers
- Reduced cars on the road, decreasing traffic congestion
- Reduced vehicle pollution
- Faster than traditional couriers, would not be stuck in the traffic or subjected to any delivery drivers' schedule
- Do not require rest like delivery drivers, able to work 24/7



seed studio



DexForce

DexForce is a start-up AI company focusing on 3D machine vision. The company develops a physics engine named Mixed AI, which can generate synthetic data to train AI models by applying cutting-edge 3D geometric deep learning technology. The company supplies 3D smart cameras and 3D vision solutions to manufacturing customers on the basis of the AI platform. DexSense 3D industrial smart camera adopts advanced active stripe structured light technology.

Find whole solution >> [DexForce](#)

Edge Device Used

Jetson Nano module

Application

Industrial 3D camera

Seed Service

Seed Fusion PCBA Service

Software

DexForce developed graphical vision algorithm platform

Use Case

Open Source 3D Camera Breaks the Cost Barrier to Industrial 3D Machine Vision with Seed Fusion PCBA

Challenge

With an increasing number of industrial robots in factories all over the world, 3D vision has received more attention due to the lack of depth information of 2D vision.

Solution

3D industrial cameras can be eyes of robots, which provide the three-dimensional spatial coordinates of an object. Powered by NVIDIA Jetson Nano, Xema is able to run 3D point cloud recognition algorithms and robotic arm control programs. Xema is also equipped with a DLP projector and a CMOS sensor, which enable the camera to perform fast imaging speed and strong anti-ambient light capability. It can generate high-resolution and precision point clouds of various objects such as reflective metal, black carbon fiber, thin cardboard, etc.

Seed Fusion provides Dexforce team with delicate manufacturing advice from 0.1 to 1. Power-efficient with a compact form factor, Jetson Modules brings accelerated AI performance to the edge.

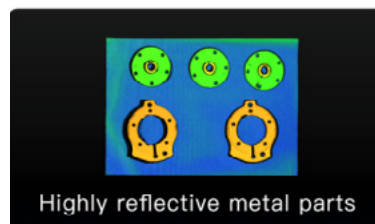
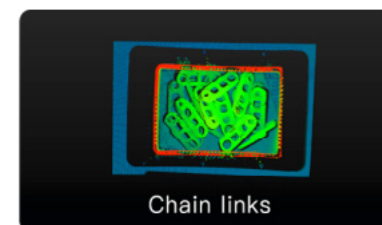
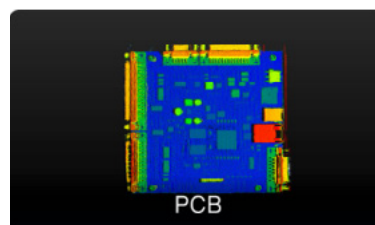



Peer Robotics

Peer Robotics is a collaborative mobile robotics company building material handling solutions for manufacturing industries. Peer Robotics mobile robots can learn from humans in real-time, allowing people on the shop floor to integrate and deploy the solutions easily.

Find whole solution >> [Peer Robotics](#)

Application

Collaborative Mobile Robot

Edge Device Used

NVIDIA Jetson AGX Xavier

Software

ROS

Use Case

Bringing Humans in the Loop to Help SMEs Automate

Challenge

Global manufacturing industries have rapidly evolved facing automation need, no matter small and medium-sized enterprises (SME) or large corporates. However, when SMEs are facing labor shortages or increased operating costs, the high cost and complexity of automation solutions make it difficult to adopt these technologies and transform quickly.

Solution

Peer Robotics believes that the future lies in collaboration between humans and robots rather than fixed automation. They are building material handling solutions that can learn from humans in real-time, allowing people on the shop floor to interact with these robots just like they would interact with a trolley. Humans can simply grab the robot, move it from point A to B, and in this process, teach the robot how to perform the tasks autonomously the next time onwards. This reduces the need for specialized engineers or training, further reducing fixed costs.

Peer Robotics utilizes Jetson Xavier and Intel NUC for the onboard computation of mapping, path planning, obstacle avoidance, and natural navigation. Along with intel real sense cameras as a key visual navigation component. Peer Robotics also develops its own custom PCB boards like charging modules, IMU boards, central control units, etc.



seed studio



Theia Scientific, LLC

Theia Scientific is a technology company that provides unclouded machine vision to microscopy instrumentation and quantitative image analysis workflows. The team is built with experts in edge computing architectures for scientific instrumentation, data analytics, and AI model development.

Find whole solution >> [Theia Scientific](#)

Application

Object Detection

Edge Devices Used

NVIDIA Jetson AGX Orin
NVIDIA Jetson AGX Xavier
NVIDIA Jetson Xavier NX
Jetson Mate

Software Support

Theiascope™ platform
PyTorch, Anyscale Grafana
Volkov Labs: open-source custom plugin for Grafana
Balena: manage IoT fleets

Use Case

Real-time AI-powered Microscopy Image Analysis at the Edge

Challenge

Microscopes are generally deployed in “network-constrained” environments and do not have dedicated GPUs for computation. Thus, it is essential to bring Cloud-like computational resources to the microscope instead of bringing microscopes to the Cloud.

Solution

Theiascope™ platform created by Theia Scientific provides real-time image and data analysis automation technology for scientists and engineers who conduct research utilizing optical, electron, and X-ray-based microscopy with instrumentation in network- and time-constrained environments.

Business Impact

This technology can cut labor costs by 80%, reduce training time and operational expertise, and accelerate the delivery of unbiased results from years, months, days, to seconds in the energy, health, manufacturing, and transportation sectors.

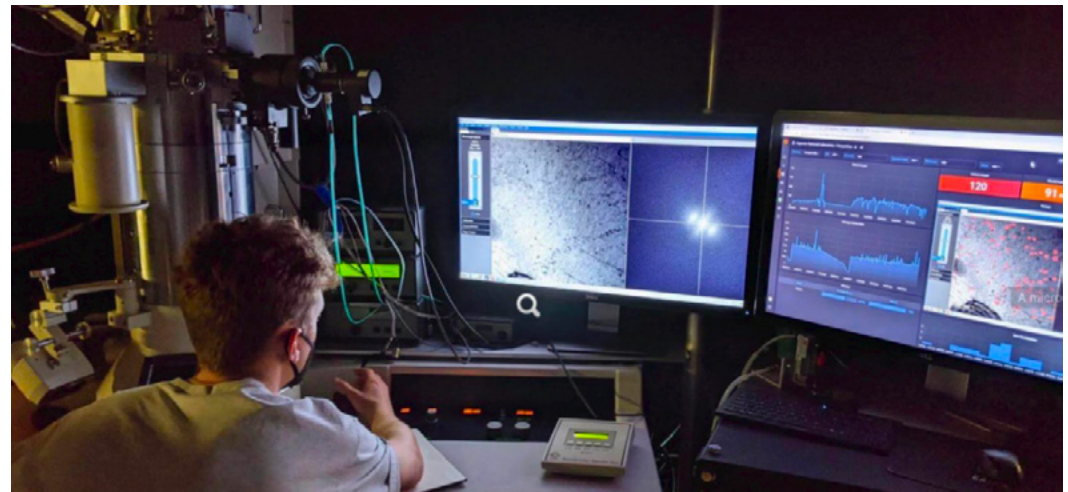



Seeed Studio

CONTACT US

Take the first step to send us an email at edgeai@seeed.cc to become a part of the amazing ecosystem!

Check out our [Latest NVIDIA Jetson Catalog](#)

Explore more about [Seeed's NVIDIA Jetson ecosystem](#)

Our office: Shenzhen, China | Nagoya, Japan | Seeed Europe(for Europe, Middle East, and Africa) | Seeed U.S.



We take actions from
your insights!